

Your Project Calculations



Project Name: W-11757 Expansion - RevB - Jb

S3D Model Link:

https://platform.skyciv.com/structural?preload_name=W-11757%20Expansion%20-%20RevB%20-%20Jb&preload_path=Shared%20Enterprise%20Folder/MT_Solar_Projects/4_2024

Public Model Link:

https://platform.skyciv.com/structural-viewer?project_id=11vL7LNVyO7Nxp2YLgeCnpSIK5V5424Wt1D3ZgdIREDtzYnSU0HKVxeoxhQM5J

Array Specification

Product:	Beam
Unique ID:	2P-15-6TOP-SD-12-L-4Hx4W-E7F2
Duty Classification:	SD
Module Width:	41.00 in
Module Length:	75.70in
Number of Rows:	4
Number of Columns:	4
Total Number of Modules:	16
Desired Tilt Angle:	50
Front Edge Clearance:	3
Total Array Height at Tilt:	13.53 ft
Total Frame Length:	24.50 ft
Frame Weight:	1058 lbs
Array Dimensions N/S:	13.83 ft
Array Dimensions E/W:	25.57 ft
Rail Length:	166.00 in
Rail Spacing:	3.15 ft
Rail Check:	Not Checked

Support Specifications

Pole Size:	6in Pipe Sch 40
Pole Length above Grade:	8.30 ft
Number of Poles:	2
Pole Spacing:	15 ft

Foundation Specifications

Foundation Type:	Square
Foundation Dimensions:	48 x 48 in
Foundation Depth (below grade):	Pile 1: 4.50 ft Pile 2: 4.50 ft
Foundation Volume:	5.333 y ³
Foundation Result:	PASSED
Mount Twist:	0.418669 kip

Site Info

Risk Category:	I
Exposure:	B
Soil Classification:	sand
Site Location:	Alaska, USA
Wind Speed:	100 mph
Snow Load:	120 psf
Design Uplift Pressure:	0.013192 ksf
Design Downforce Pressure:	-0.013192 ksf
Design Snow Pressure:	0.026391 ksf

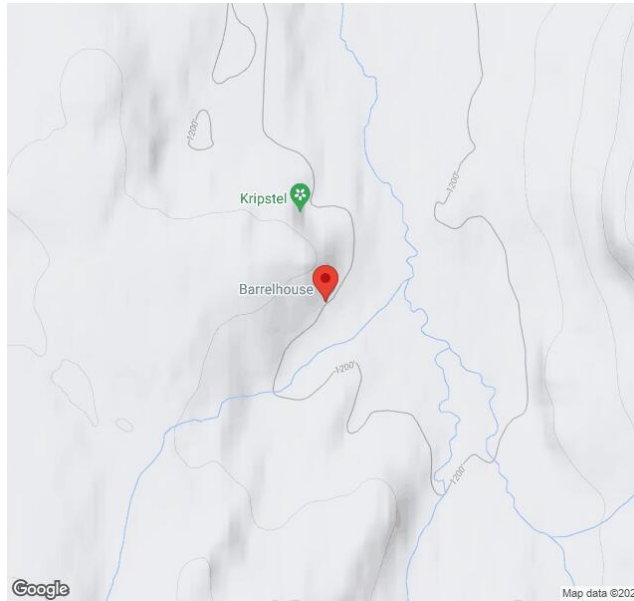

Design Disclaimer

This software should be used for preliminary designs and should not be used as a final design unless reviewed, verified and designed by a qualified structural engineer.

AutoDesigner Input

```
{"wind_speed_override":100,"snow_load_override":120,"direct_snow_load":false,"add_angle_brace":true,"product_type":"Beam","project_id":"W-11757 Expansion - RevB - Jb","site_address":"Alaska, USA","module_width":41,"module_length":75.7,"number_rows":4,"number_columns":4,"pole_mount_section":"4_40","core_pipe_width":65,"core_pipe_section":"2_40","adjuster_section":"2_40","core_beam_height":65,"core_beam_section":"HSS3x2x1/8","main_pipe_section":"2_12GA","pole_spacing":15,"tilt_angle":50,"ground_clearance":3,"risk_category":"I","exposure_category":"B","frame_duty_override":"auto","pole_override":"auto","soil_type":"sand","customer_foundation_override":"48_Square","foundation_type":"Square","foundation_size":48,"check_rails":false}
```

Design Notes:

- AISC Deflection checks are set to L/1 due to structure design intent
- Foundation Soil Parameters used in this Autodesign are all estimates, proper geotechnical reports are required to confirm soil profiles
- Wind speeds, snow loads and other site specific results are based on ASCE 7 2016
- Steel frame design checks are based on AISC 360 2016 (LRFD)
- Foundation Design and Sizing is approximate only

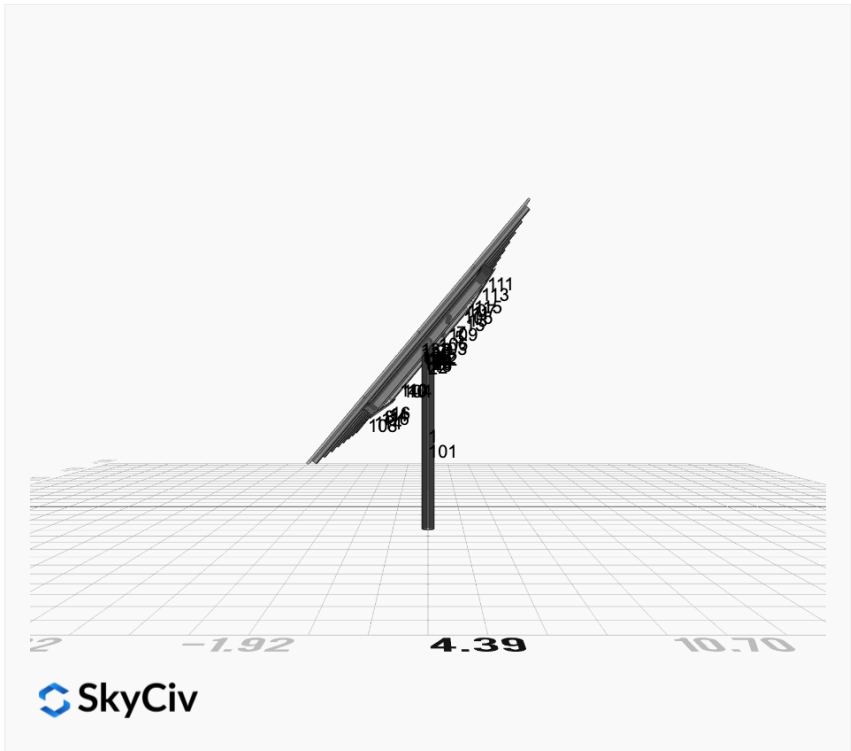
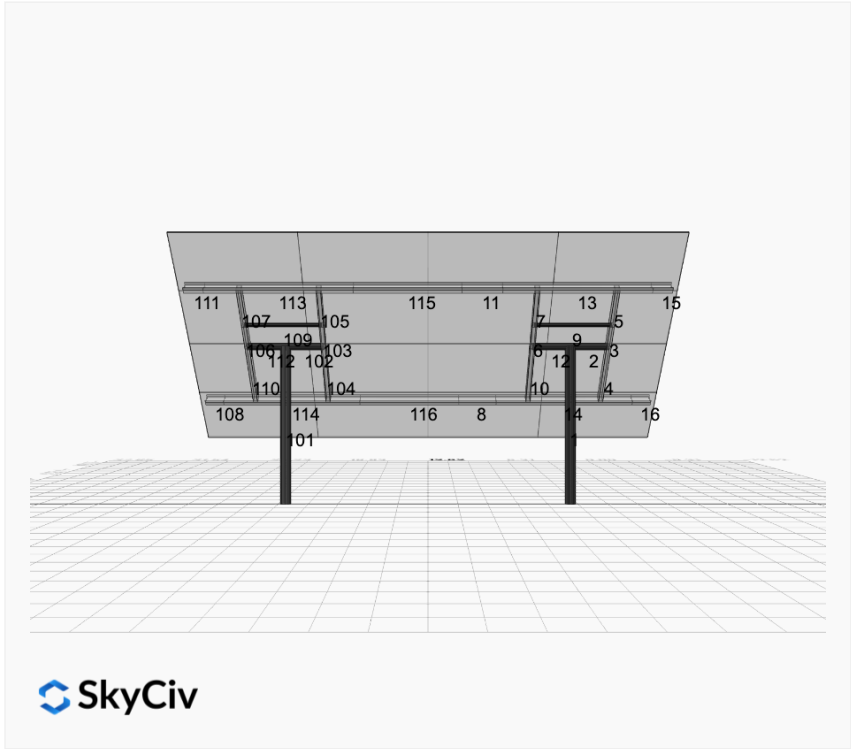

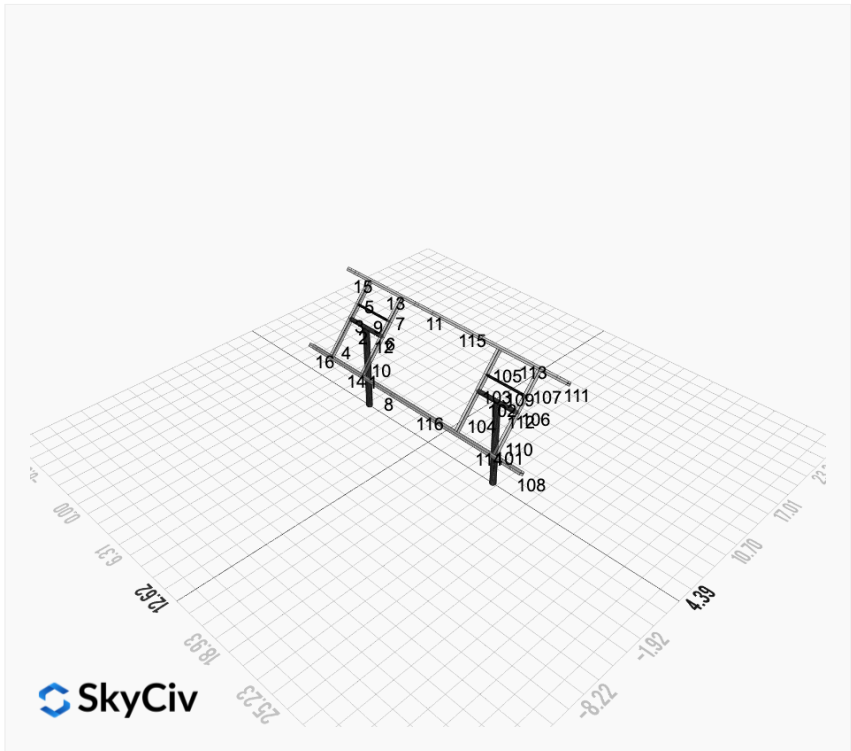
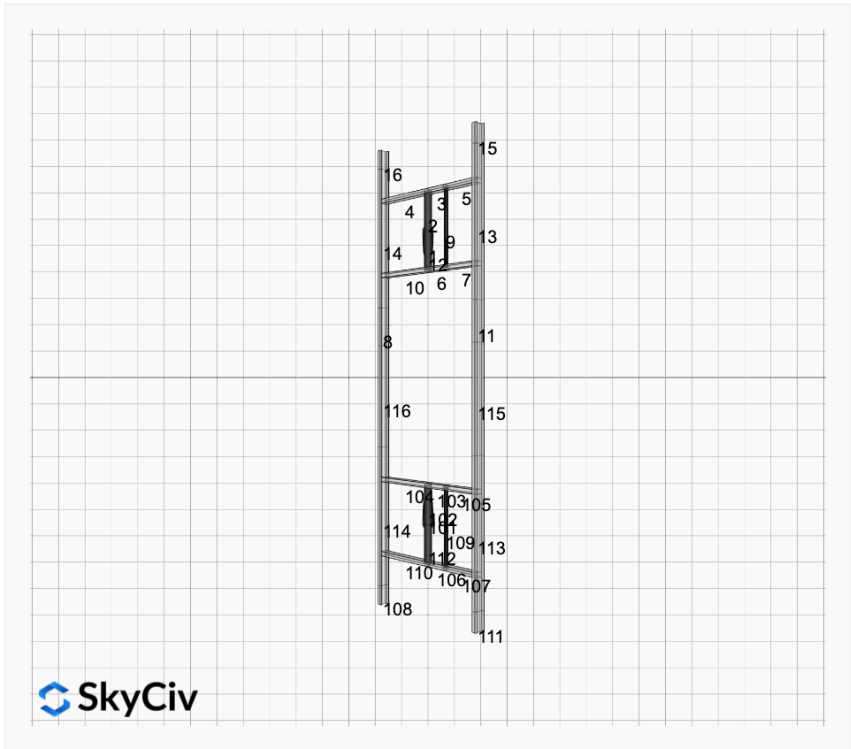

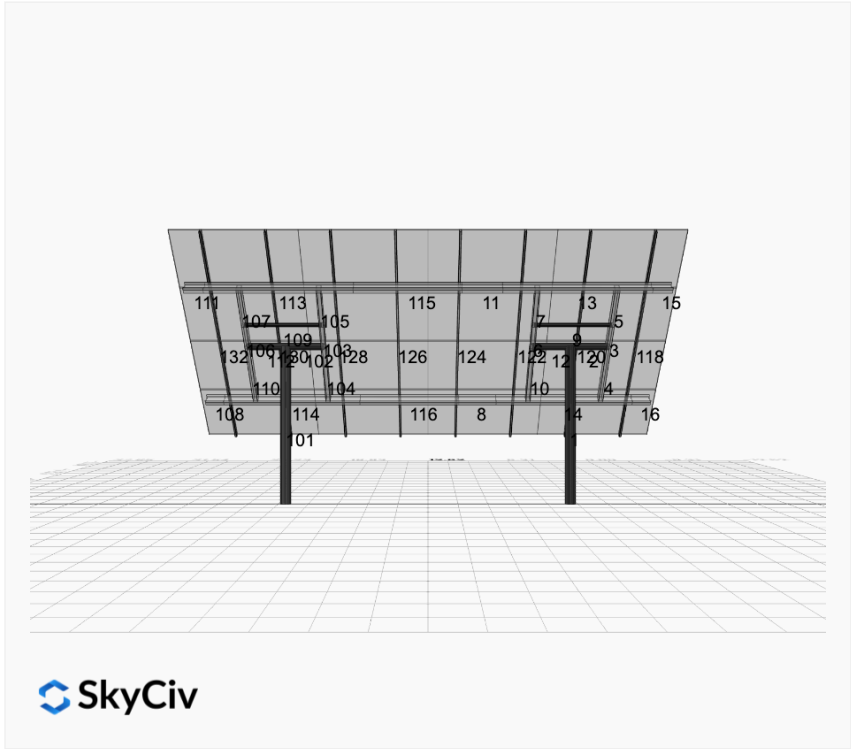

FEM Results (Envelope Worst Case for each member)

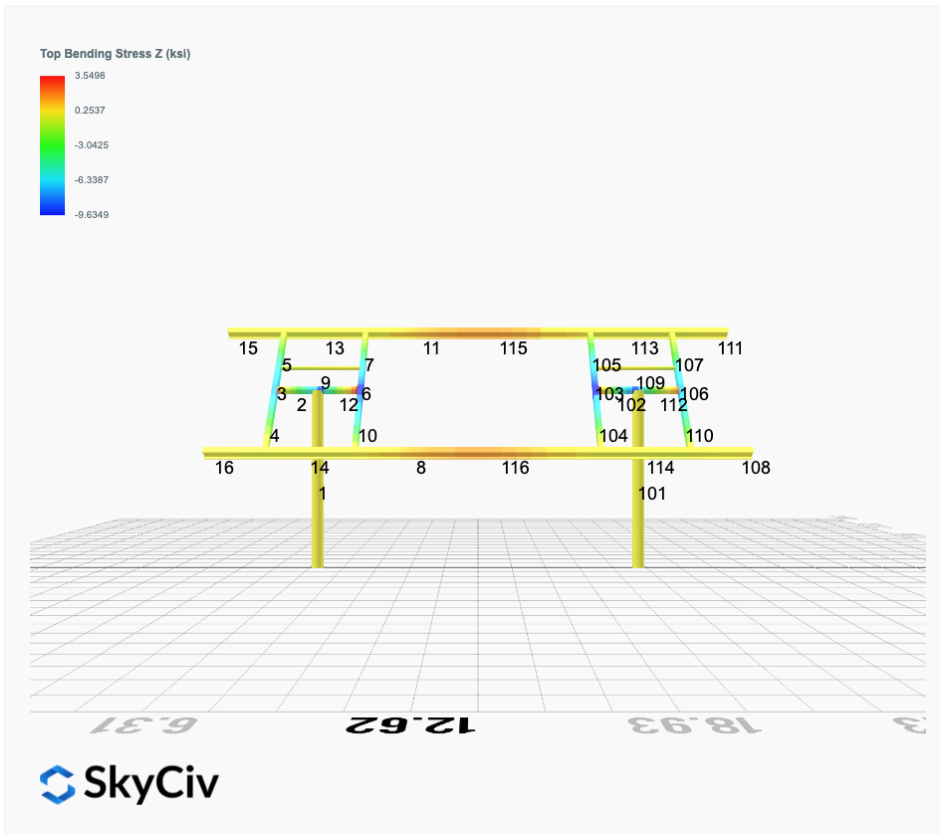
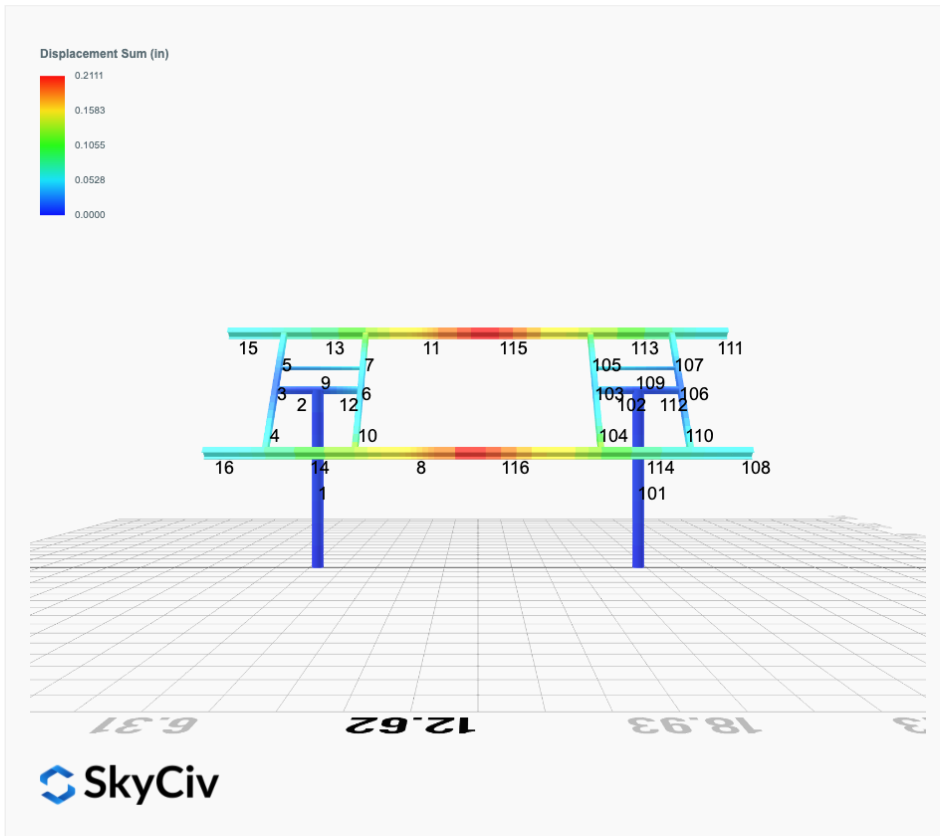

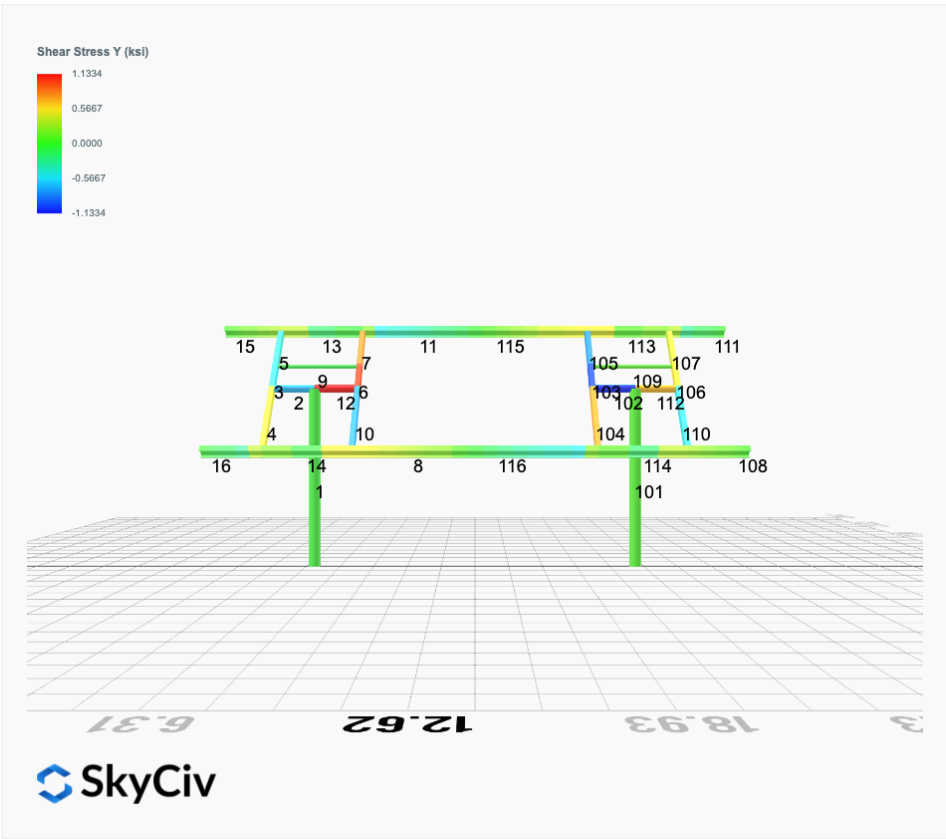
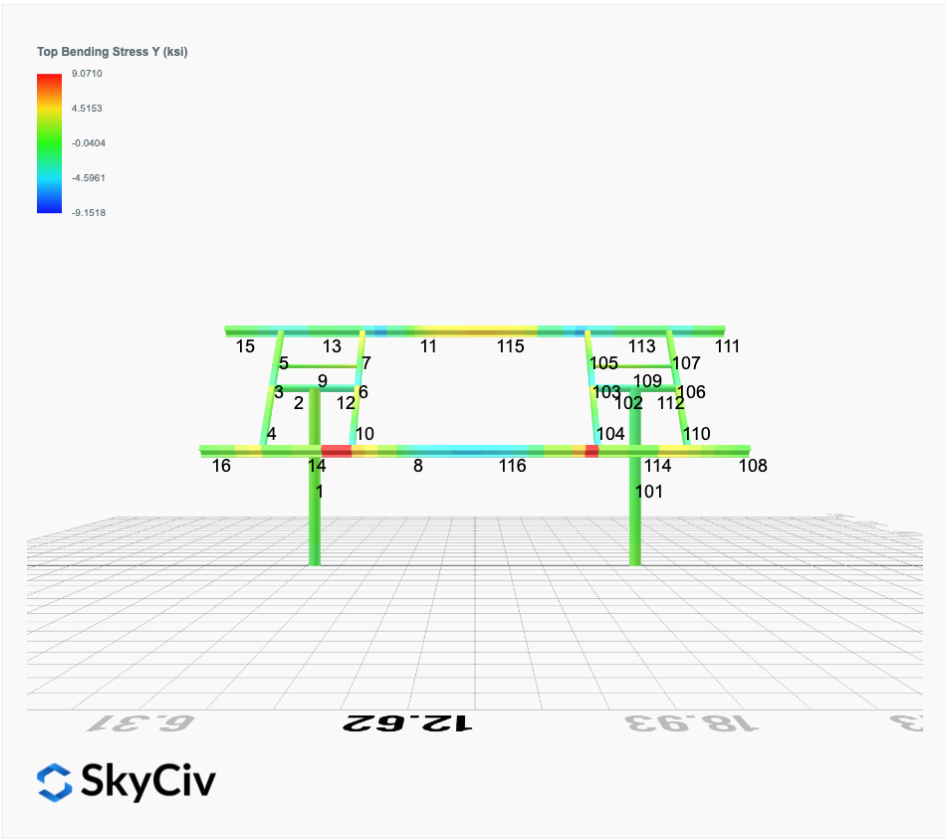

Reaction Forces for Foundation 1 (Node ID#1), (kip, kip-ft)

ASD Load Combination Results

Name	Fx	Fy	Fz	Mx	My	Mz
ULS: 1. D	0.0000	1.3565	0.0474	0.1145	-0.0392	0.0148
ULS: 2. D + L	0.0000	1.3565	0.0474	0.1145	-0.0392	0.0148
ULS: 3. D + (S or Lr or R)	0.0000	4.2312	0.1778	0.4294	-0.1476	0.0302
ULS: 3. D + (S or Lr or R)	0.0000	1.3565	0.0474	0.1145	-0.0392	0.0148
ULS: 4. D + 0.75L + 0.75(S or Lr or R)	0.0000	3.5126	0.1452	0.3507	-0.1205	0.0263
ULS: 4. D + 0.75L + 0.75(S or Lr or R)	0.0000	1.3565	0.0474	0.1145	-0.0392	0.0148
ULS: 5b. D + 0.7E	0.0000	1.3565	0.0474	0.1145	-0.0392	0.0148
ULS: 6b. D + 0.75L + 0.75(0.7)E + 0.75S	0.0000	3.5126	0.1452	0.3507	-0.1205	0.0263
ULS: 8. 0.6D + 0.7E	0.0000	0.8139	0.0285	0.0687	-0.0235	0.0089
ULS: 5a. D + 0.6W_Wind downforce Case A only	-1.0722	2.2562	0.1081	0.2513	-0.2302	8.9669
ULS: 5a. D + 0.6W_Wind downforce Case B only	0.0000	1.3565	0.0474	0.1145	-0.0392	0.0148
ULS: 5a. D + 0.6W_Wind uplift Case A only	1.0722	0.4569	-0.0131	-0.0220	0.1518	-8.8293
ULS: 5a. D + 0.6W_Wind uplift Case B only	0.0000	1.3565	0.0474	0.1145	-0.0392	0.0148
ULS: 6a. D + 0.75L + 0.75(0.6)W + 0.75(S or Lr or R)_Wind downforce Case A only	-0.8042	4.1873	0.1907	0.4533	-0.2637	6.7405
ULS: 6a. D + 0.75L + 0.75(0.6)W + 0.75(S or Lr or R)_Wind downforce Case B only	0.0000	3.5126	0.1452	0.3507	-0.1205	0.0263
ULS: 6a. D + 0.75L + 0.75(0.6)W + 0.75(S or Lr or R)_Wind uplift Case A only	0.8042	2.8378	0.0998	0.2483	0.0228	-6.6067
ULS: 6a. D + 0.75L + 0.75(0.6)W + 0.75(S or Lr or R)_Wind uplift Case B only	0.0000	3.5126	0.1452	0.3507	-0.1205	0.0263
ULS: 6a. D + 0.75L + 0.75(0.6)W + 0.75(S or Lr or R)_Wind downforce Case A only	-0.8042	2.0313	0.0929	0.2171	-0.1825	6.7289
ULS: 6a. D + 0.75L + 0.75(0.6)W + 0.75(S or Lr or R)_Wind downforce Case B only	0.0000	1.3565	0.0474	0.1145	-0.0392	0.0148
ULS: 6a. D + 0.75L + 0.75(0.6)W + 0.75(S or Lr or R)_Wind uplift Case A only	0.8042	0.6818	0.0020	0.0121	0.1041	-6.6183
ULS: 6a. D + 0.75L + 0.75(0.6)W + 0.75(S or Lr or R)_Wind uplift Case B only	0.0000	1.3565	0.0474	0.1145	-0.0392	0.0148
ULS: 7. 0.6D + 0.6W_Wind downforce Case A only	-1.0722	1.7136	0.0891	0.2055	-0.2146	8.9610
ULS: 7. 0.6D + 0.6W_Wind downforce Case B only	0.0000	0.8139	0.0285	0.0687	-0.0235	0.0089
ULS: 7. 0.6D + 0.6W_Wind uplift Case A only	1.0722	-0.0858	-0.0321	-0.0678	0.1675	-8.8352
ULS: 7. 0.6D + 0.6W_Wind uplift Case B only	0.0000	0.8139	0.0285	0.0687	-0.0235	0.0089

Worst Case Reactions LRFD

These calculations are taken directly from the FEA via SkyCiv and are used in the Concrete Checks of the Foundation Module.
Note: Worst case values are assumed as downforce wind load cases.

Result	Value (kip, kip-ft)
Axial	6.9771
Shear X	-1.7870
Shear Z	0.3164
Moment X	0.7578
Moment Y (Twist)	0.4187
Moment Z	15.1597

Worst Case Reactions ASD

These results are taken from the worst case values in the above table and are used in the Soil Checks in the Foundation Module.
Note: Worst case values are assumed as downforce wind load cases.

Result	Value (kip, kip-ft)
Axial	4.2312
Shear X	-1.0722
Shear Z	0.1907
Moment X	0.4533
Moment Y (Twist)	0.2637
Moment Z	8.9669

Reaction Forces for Foundation 2 (Node ID#101), (kip, kip-ft)

ASD Load Combination Results

Name	Fx	Fy	Fz	Mx	My	Mz
ULS: 1. D	-0.0000	1.3565	-0.0474	-0.1145	0.0392	0.0148
ULS: 2. D + L	-0.0000	1.3565	-0.0474	-0.1145	0.0392	0.0148
ULS: 3. D + (S or Lr or R)	-0.0000	4.2312	-0.1778	-0.4294	0.1476	0.0302
ULS: 3. D + (S or Lr or R)	-0.0000	1.3565	-0.0474	-0.1145	0.0392	0.0148
ULS: 4. D + 0.75L + 0.75(S or Lr or R)	-0.0000	3.5126	-0.1452	-0.3507	0.1205	0.0263
ULS: 4. D + 0.75L + 0.75(S or Lr or R)	-0.0000	1.3565	-0.0474	-0.1145	0.0392	0.0148
ULS: 5b. D + 0.7E	-0.0000	1.3565	-0.0474	-0.1145	0.0392	0.0148

Name	Fx	Fy	Fz	Mx	My	Mz
ULS: 6b. D + 0.75L + 0.75(0.7)E + 0.75S	-0.0000	3.5126	-0.1452	-0.3507	0.1205	0.0263
ULS: 8. 0.6D + 0.7E	-0.0000	0.8139	-0.0285	-0.0687	0.0235	0.0089
ULS: 5a. D + 0.6W_Wind downforce Case A only	-1.0722	2.2562	-0.1081	-0.2513	0.2302	8.9669
ULS: 5a. D + 0.6W_Wind downforce Case B only	-0.0000	1.3565	-0.0474	-0.1145	0.0392	0.0148
ULS: 5a. D + 0.6W_Wind uplift Case A only	1.0722	0.4569	0.0131	0.0220	-0.1518	-8.8293
ULS: 5a. D + 0.6W_Wind uplift Case B only	-0.0000	1.3565	-0.0474	-0.1145	0.0392	0.0148
ULS: 6a. D + 0.75L + 0.75(0.6)W + 0.75(S or Lr or R)_Wind downforce Case A only	-0.8042	4.1873	-0.1907	-0.4533	0.2638	6.7405
ULS: 6a. D + 0.75L + 0.75(0.6)W + 0.75(S or Lr or R)_Wind downforce Case B only	-0.0000	3.5126	-0.1452	-0.3507	0.1205	0.0263
ULS: 6a. D + 0.75L + 0.75(0.6)W + 0.75(S or Lr or R)_Wind uplift Case A only	0.8042	2.8378	-0.0998	-0.2483	-0.0228	-6.6067
ULS: 6a. D + 0.75L + 0.75(0.6)W + 0.75(S or Lr or R)_Wind uplift Case B only	-0.0000	3.5126	-0.1452	-0.3507	0.1205	0.0263
ULS: 6a. D + 0.75L + 0.75(0.6)W + 0.75(S or Lr or R)_Wind downforce Case A only	-0.8042	2.0313	-0.0929	-0.2171	0.1825	6.7289
ULS: 6a. D + 0.75L + 0.75(0.6)W + 0.75(S or Lr or R)_Wind downforce Case B only	-0.0000	1.3565	-0.0474	-0.1145	0.0392	0.0148
ULS: 6a. D + 0.75L + 0.75(0.6)W + 0.75(S or Lr or R)_Wind uplift Case A only	0.8042	0.6818	-0.0020	-0.0121	-0.1041	-6.6183
ULS: 6a. D + 0.75L + 0.75(0.6)W + 0.75(S or Lr or R)_Wind uplift Case B only	-0.0000	1.3565	-0.0474	-0.1145	0.0392	0.0148
ULS: 7. 0.6D + 0.6W_Wind downforce Case A only	-1.0722	1.7136	-0.0891	-0.2055	0.2146	8.9610
ULS: 7. 0.6D + 0.6W_Wind downforce Case B only	-0.0000	0.8139	-0.0285	-0.0687	0.0235	0.0089
ULS: 7. 0.6D + 0.6W_Wind uplift Case A only	1.0722	-0.0858	0.0321	0.0678	-0.1675	-8.8352
ULS: 7. 0.6D + 0.6W_Wind uplift Case B only	-0.0000	0.8139	-0.0285	-0.0687	0.0235	0.0089

Worst Case Reactions LRFD

These calculations are taken directly from the FEA via SkyCiv and are used in the Concrete Checks of the Foundation Module.
Note: Worst case values are assumed as downforce wind load cases.

Result	Value (kip, kip-ft)
Axial	6.9771
Shear X	-1.7870
Shear Z	-0.3164
Moment X	-0.7577
Moment Y (Twist)	0.4187
Moment Z	15.1600

Worst Case Reactions ASD

These results are taken from the worst case values in the above table and are used in the Soil Checks in the Foundation Module.
Note: Worst case values are assumed as downforce wind load cases.

Result	Value (kip, kip-ft)
Axial	4.2312
Shear X	-1.0722
Shear Z	-0.1907
Moment X	-0.4533
Moment Y (Twist)	0.2638
Moment Z	8.9669

Project Details

Design Code: AISC 360-16 LRFD
 Provision: LRFD
 Country: United States
 User Name: sales@mtsolar.us
 Unit System: imperial



Design Input Information

Design Factors			
Φ_t	Φ_c	Φ_b	Φ_v
0.9	0.9	0.9	0.9

Design Materials			
ID	E (ksi)	F_y (ksi)	F_u (ksi)
1	29000	50	65

Section Dimensions



ID	Name	d (in)	t_w (in)				
1	2in Pipe Sch 40	2.38	0.15				
4	4in Pipe Sch 40	4.50	0.24				
7	6in Pipe Sch 40	6.63	0.28				



ID	Name	d (in)	b (in)	t_w (in)	t_b (in)	r (in)	
15	HSS5x3x1/8	5.00	3.00	0.12	0.12	0.12	



ID	Name	d (in)	t_w (in)	b_t (in)	b_b (in)	t_t (in)	t_b (in)	r (in)
18	W6x9	5.90	0.17	3.94	3.94	0.21	0.21	0.25

Section Properties

ID	Name	A (in ²)	J (in ⁴)	I_{yp} (in ⁴)	I_{zp} (in ⁴)	I_w (in ⁶)	S_{yp} (in ³)	S_{zp} (in ³)
1	2in Pipe Sch 40	1.07	1.33	0.67	0.67	0.00	0.76	0.76
4	4in Pipe Sch 40	3.17	14.47	7.23	7.23	0.00	4.31	4.31
7	6in Pipe Sch 40	5.58	56.28	28.14	28.14	0.00	11.28	11.28

15	HSS5x3x1/8	1.77	6.02	2.75	6.03	0.51	2.07	2.93
18	W6x9	2.68	0.04	2.20	16.40	17.70	1.72	6.23

Member Properties												
Member ID	Section ID	K _z L (ft)	K _y L (ft)	L _b (ft)	C _b	L	S	T	L	S	L	D
1	7	17.43	17.43	8.30	-	3	0	0	2	0	0	1
2	4	1.30	1.30	2.00	-	3	0	0	2	0	0	1
3	15	0.92	0.92	1.42	1.19,1.18,1.19,1.18,1.18,1.19,1.18,1.18,1.16,1.18,1.18,1.19,1.17,1.19,1.18,1.18,1.18,1.18,1.18,1.19,1.15,1.19,1.18,1.19,1.17,1.19	3	0	0	2	0	0	1
4	15	2.44	2.44	3.75	1.69,1.68,1.69,1.67,1.68,1.69,1.67,1.68,1.64,1.68,1.67,1.69,1.65,1.69,1.67,1.67,1.67,1.67,1.68,1.69,1.61,1.69,1.67,1.69,1.66,1.69	3	0	0	2	0	0	1
5	15	1.52	1.52	2.33	1.68,1.67,1.68,1.67,1.68,1.68,1.67,1.67,1.65,1.67,1.67,1.68,1.66,1.68,1.67,1.67,1.67,1.67,1.67,1.68,1.63,1.68,1.67,1.68,1.66,1.68	3	0	0	2	0	0	1
6	15	0.92	0.92	1.42	1.19,1.19,1.19,1.18,1.19,1.19,1.18,1.19,1.17,1.19,1.18,1.19,1.18,1.19,1.18,1.18,1.18,1.18,1.19,1.16,1.19,1.18,1.19,1.18,1.19	3	0	0	2	0	0	1
7	15	1.52	1.52	2.33	1.68,1.67,1.68,1.67,1.67,1.68,1.67,1.67,1.65,1.67,1.67,1.68,1.66,1.68,1.67,1.67,1.67,1.67,1.67,1.68,1.64,1.68,1.67,1.68,1.66,1.68	3	0	0	2	0	0	1
8	18	1.33	1.33	2.05	1.19,1.19,1.19,1.19,1.19,1.19,1.19,1.19,1.16,1.19,1.19,1.19,1.18,1.19,1.19,1.19,1.20,1.19,1.19,1.19,1.17,1.19,1.19,1.19,1.18,1.19	3	0	0	2	0	0	1
9	1	2.60	2.60	4.00	-	3	0	0	2	0	0	1
10	15	2.44	2.44	3.75	1.69,1.68,1.69,1.67,1.68,1.69,1.67,1.68,1.64,1.68,1.67,1.69,1.66,1.69,1.67,1.67,1.67,1.67,1.67,1.67,1.62,1.69,1.67,1.69,1.66,1.69	3	0	0	2	0	0	1
11	18	1.33	1.33	2.05	1.19,1.19,1.19,1.19,1.19,1.19,1.19,1.19,1.16,1.19,1.19,1.19,1.18,1.19,1.19,1.19,1.20,1.19,1.19,1.19,1.17,1.19,1.19,1.19,1.18,1.19	3	0	0	2	0	0	1
12	4	2.00	1.30	2.00	-	3	0	0	2	0	0	1
13	18	4.88	4.00	7.50	1.51,1.53,1.51,1.54,1.52,1.51,1.63,1.53,2.29,1.53,1.65,1.51,1.81,1.51,1.58,1.54,1.46,1.54,1.62,1.51,2.20,1.51,1.66,1.51,1.77,1.51	3	0	0	2	0	0	1
14	18	4.88	4.00	7.50	1.48,1.50,1.48,1.50,1.49,1.48,1.60,1.50,2.26,1.50,1.62,1.48,1.78,1.48,1.54,1.50,1.43,1.50,1.59,1.48,2.20,1.48,1.63,1.48,1.74,1.48	3	0	0	2	0	0	1
15	18	2.10	2.10	1.00	2.33,2.33,2.33,2.33,2.33,2.33,2.33,2.33,2.33,2.33,2.33,2.33,2.33,2.33,2.33,2.33,2.33,2.33,2.33,2.32,2.33,2.33,2.33,2.33,2.33	3	0	0	2	0	0	1
16	18	2.10	2.10	1.00	2.33,2.33,2.33,2.33,2.33,2.33,2.33,2.33,2.33,2.33,2.33,2.33,2.33,2.33,2.33,2.33,2.33,2.33,2.33,2.32,2.33,2.33,2.33,2.33,2.33	3	0	0	2	0	0	1
101	7	17.43	17.43	8.30	-	3	0	0	2	0	0	1
102	4	2.00	1.30	2.00	-	3	0	0	2	0	0	1
103	15	0.92	0.92	1.42	1.19,1.19,1.19,1.18,1.19,1.19,1.18,1.19,1.17,1.19,1.18,1.19,1.18,1.19,1.18,1.18,1.18,1.18,1.19,1.16,1.19,1.18,1.19,1.18,1.19	3	0	0	2	0	0	1
104	15	2.44	2.44	3.75	1.69,1.68,1.69,1.67,1.68,1.69,1.67,1.68,1.64,1.68,1.67,1.69,1.66,1.69,1.67,1.67,1.67,1.67,1.67,1.62,1.69,1.67,1.69,1.66,1.69	3	0	0	2	0	0	1
105	15	1.52	1.52	2.33	1.68,1.67,1.68,1.67,1.67,1.68,1.67,1.67,1.65,1.67,1.67,1.68,1.66,1.68,1.67,1.67,1.67,1.67,1.67,1.68,1.64,1.68,1.67,1.68,1.66,1.68	3	0	0	2	0	0	1
106	15	0.92	0.92	1.42	1.19,1.18,1.19,1.18,1.18,1.19,1.18,1.18,1.16,1.18,1.18,1.19,1.17,1.19,1.18,1.18,1.18,1.18,1.18,1.19,1.15,1.19,1.18,1.19,1.17,1.19	3	0	0	2	0	0	1
107	15	1.52	1.52	2.33	1.68,1.67,1.68,1.67,1.68,1.68,1.67,1.67,1.65,1.67,1.67,1.68,1.66,1.68,1.67,1.67,1.67,1.67,1.67,1.68,1.63,1.68,1.67,1.68,1.66,1.68	3	0	0	2	0	0	1

115	120.00	95.07	21.54	6.45	30.09	45.74
116	120.60	95.07	21.54	6.45	30.09	45.74

Design Ratio

Member ID	P	M _z	M _y	V _y	V _z	(P,M _z ,M _y)	Worst LC	KL/r	δ	Status
1	0.052	0.358	0.044	0.024	0.004	0.388	#13	0.466	Not Required	Pass
2	0.001	0.255	0.104	0.065	0.021	0.336	#21	0.052	Not Required	Pass
3	0.013	0.381	0.121	0.038	0.022	0.503	#21	0.044	Not Required	Pass
4	0.010	0.377	0.132	0.038	0.018	0.514	#21	0.078	Not Required	Pass
5	0.012	0.237	0.058	0.038	0.005	0.258	#21	0.073	Not Required	Pass
6	0.018	0.476	0.291	0.049	0.054	0.777	#21	0.044	Not Required	Pass
7	0.019	0.295	0.270	0.047	0.038	0.354	#21	0.073	Not Required	Pass
8	0.003	0.101	0.121	0.025	0.015	0.224	#21	0.088	Not Required	Pass
9	0.006	0.043	0.076	0.004	0.004	0.087	#21	0.132	Not Required	Pass
10	0.019	0.472	0.244	0.048	0.034	0.677	#21	0.078	Not Required	Pass
11	0.005	0.101	0.121	0.025	0.015	0.223	#21	0.088	Not Required	Pass
12	0.003	0.371	0.130	0.094	0.024	0.476	#21	0.079	Not Required	Pass
13	0.006	0.053	0.270	0.037	0.022	0.291	#21	0.265	Not Required	Pass
14	0.003	0.053	0.267	0.037	0.022	0.284	#21	0.177	Not Required	Pass
15	0.000	0.004	0.014	0.007	0.004	0.019	#21	Not Required	Not Required	Pass
16	0.000	0.004	0.014	0.007	0.004	0.019	#21	Not Required	Not Required	Pass
101	0.052	0.358	0.044	0.024	0.004	0.388	#13	0.466	Not Required	Pass
102	0.003	0.371	0.130	0.094	0.024	0.476	#21	0.079	Not Required	Pass
103	0.018	0.476	0.291	0.049	0.054	0.777	#21	0.044	Not Required	Pass
104	0.019	0.472	0.244	0.048	0.034	0.677	#21	0.078	Not Required	Pass
105	0.019	0.295	0.270	0.047	0.038	0.354	#21	0.073	Not Required	Pass
106	0.013	0.381	0.121	0.038	0.022	0.503	#21	0.044	Not Required	Pass
107	0.012	0.237	0.058	0.038	0.005	0.258	#21	0.073	Not Required	Pass
108	0.000	0.004	0.014	0.007	0.004	0.019	#21	Not Required	Not Required	Pass
109	0.006	0.043	0.076	0.004	0.004	0.087	#21	0.132	Not Required	Pass
110	0.010	0.377	0.132	0.038	0.018	0.514	#21	0.078	Not Required	Pass
111	0.000	0.004	0.014	0.007	0.004	0.019	#21	Not Required	Not Required	Pass
112	0.001	0.255	0.104	0.065	0.021	0.336	#21	0.052	Not Required	Pass
113	0.006	0.053	0.270	0.037	0.022	0.291	#21	0.177	Not Required	Pass
114	0.003	0.053	0.267	0.037	0.022	0.284	#21	0.265	Not Required	Pass
115	0.006	0.121	0.161	0.025	0.015	0.284	#21	0.235	Not Required	Pass
116	0.003	0.122	0.161	0.025	0.015	0.284	#21	0.235	Not Required	Pass

Definitions

Φ _t	Safety factor for tensile
Φ _c	Safety factor for compression
Φ _b	Safety factor for flexure
Φ _v	Safety factor for shear
E	Modulus of elasticity
F _y	Specified minimum yield stress
F _u	Specified minimum tensile strength
A	Cross-sectional area
J	Torsional constant
I _{yp}	Moment of inertia about the Y axes
I _{zp}	Moment of inertia about the Z axes
I _w	Warping constant
S _{yp}	Plastic section modulus about the Y axis
S _{zp}	Plastic section modulus about the Z axis
KL	Effective length
C _b	Buckling modification factor (from all load combinations)
L _r	Length between braced points

L	Length between brace points
LST	Limited slenderness for tension
LSC	Limited slenderness for compression
LD	Limited deflection
P_n	Nominal axial strength (tension/compression)
M_n	Nominal flexural strength (about Z/Y axis)
V_n	Nominal shear strength (along Z/Y axis)
P	Design ratio in case of axial force
M_z	Design ratio in case of bending about Z axis
M_y	Design ratio in case of bending about Y axis
V_y	Design ratio in case of shear along Y axis
V_z	Design ratio in case of shear along Z axis
(P, M_z , M_y)	Design ratio in case of axial force and bending action
KL/r	Design ratio in case of section slenderness
δ	Design ratio in case of member deflection
OK	Capacity is provided
NG	Capacity is not provided

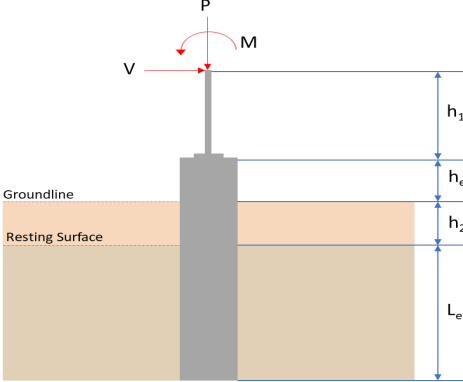
REFERENCES	CALCULATIONS	RESULTS																										
	<p>SkyCiv Foundation Design Pile Foundation</p> <p>Design Information : Design code : IBC 2021 (International Building Code) Unit System : Imperial</p>																											
	<p>Pile Input</p>  <p>Geometry Pile shape: rectangular $b = 48$ in - Pile width $D = 48$ in - Pile depth $L = 4.5$ ft - Total pile length $h_1 = 0$ ft - Lateral load height from the top of the pile, $h_2 = 0$ ft - Depth to resting surface $h_e = 0$ ft - Length of pile above the ground</p> <p>Tabulation of Soil Parameters</p> <table border="1" data-bbox="416 1102 1193 1191"> <thead> <tr> <th>Layer</th> <th>Label</th> <th>Allowable Bearing Pressure (q_a) (psf)</th> <th>Allowable Lateral Pressure (R) (psf/ft)</th> </tr> </thead> <tbody> <tr> <td>1</td> <td>Sand, silty sand, clayey sand, silty gravel & clayey gravel</td> <td>2000.000</td> <td>150.000</td> </tr> </tbody> </table> <p>Tabulation of Loads</p> <table border="1" data-bbox="676 1285 933 1458"> <thead> <tr> <th>Load Component</th> <th>ASD</th> <th>LRFD</th> </tr> </thead> <tbody> <tr> <td>P (kip)</td> <td>4.231</td> <td>6.977</td> </tr> <tr> <td>V_x (kip)</td> <td>-1.072</td> <td>-1.787</td> </tr> <tr> <td>V_z (kip)</td> <td>0.191</td> <td>0.316</td> </tr> <tr> <td>M_x (kipft)</td> <td>0.453</td> <td>0.758</td> </tr> <tr> <td>M_z (kipft)</td> <td>8.967</td> <td>15.160</td> </tr> </tbody> </table> <p>Material Properties $f'_{ck} = 2.5$ ksi - Concrete strength,</p>	Layer	Label	Allowable Bearing Pressure (q_a) (psf)	Allowable Lateral Pressure (R) (psf/ft)	1	Sand, silty sand, clayey sand, silty gravel & clayey gravel	2000.000	150.000	Load Component	ASD	LRFD	P (kip)	4.231	6.977	V_x (kip)	-1.072	-1.787	V_z (kip)	0.191	0.316	M_x (kipft)	0.453	0.758	M_z (kipft)	8.967	15.160	
Layer	Label	Allowable Bearing Pressure (q_a) (psf)	Allowable Lateral Pressure (R) (psf/ft)																									
1	Sand, silty sand, clayey sand, silty gravel & clayey gravel	2000.000	150.000																									
Load Component	ASD	LRFD																										
P (kip)	4.231	6.977																										
V_x (kip)	-1.072	-1.787																										
V_z (kip)	0.191	0.316																										
M_x (kipft)	0.453	0.758																										
M_z (kipft)	8.967	15.160																										
	<p>Required depth to resist lateral loads (ASD) H - Point of application of the lateral load</p> $H = h_1 + h_2 + h_e$ $H = (0 \text{ ft}) + (0 \text{ ft}) + (0 \text{ ft})$ $H = 0 \text{ ft}$ <p>Considering x-direction: H_o - Lateral force per length of pile,</p> $H_o = \frac{V_x}{1.57 D}$ $H_o = \frac{(-1.072 \text{ kip})}{1.57 \times (48 \text{ in})}$ $H_o = -0.1707 \text{ kip/ft}$ <p>M_o - Moment per length of pile,</p> $M_o = \frac{M_z + (V_x H)}{1.57 D}$																											

$$M_o = \frac{(8.967 \text{ kipft}) + ((-1.072 \text{ kip}) \times (0 \text{ ft}))}{1.57 \times (48 \text{ in})}$$

$$M_o = 1.4279 \text{ kipft/ft}$$

Required depth of embedment in earth:

$$L_x^3 - \left(14.14 \times \frac{H_o \times L_x}{R}\right) - \left(18.85 \times \frac{M_o}{R}\right) = 0$$

Solving the cubic equation:

$L_{e,x} = 4.1541 \text{ ft}$ - Required depth in x-direction,

Considering z-direction:

H_o - Lateral force per length of pile,

$$H_o = \frac{V_z}{1.57 b}$$

$$H_o = \frac{(0.191 \text{ kip})}{1.57 \times (48 \text{ in})}$$

$$H_o = 0.030414 \text{ kip/ft}$$

M_o - Moment per length of pile,

$$M_o = \frac{M_x + (V_z H)}{1.57 b}$$

$$M_o = \frac{(0.453 \text{ kipft}) + ((0.191 \text{ kip}) \times (0 \text{ ft}))}{1.57 \times (48 \text{ in})}$$

$$M_o = 0.072134 \text{ kipft/ft}$$

Required depth of embedment in earth:

$$L_z^3 - \left(14.14 \times \frac{H_o \times L_z}{R}\right) - \left(18.85 \times \frac{M_o}{R}\right) = 0$$

Solving the cubic equation:

$L_{e,z} = 2.1294 \text{ ft}$ - Required depth in z-direction,

Minimum embedded depth required:

$L_{e,req}$ - Depth of pile required,

$$L_{e,req} = \text{MAX}[L_{e,x}, L_{e,z}]$$

$$L_{e,req} = \text{MAX}[(4.1541 \text{ ft}), (2.1294 \text{ ft})]$$

$$L_{e,req} = 4.154 \text{ ft}$$

L_e - Actual embedded length of pile,

$$L_e = L - h_c - h_2$$

$$L_e = (4.5 \text{ ft}) - (0 \text{ ft}) - (0 \text{ ft})$$

$$L_e = 4.5 \text{ ft}$$

Ratio - Embedded depth

$$\text{Ratio} = \frac{L_{e,req}}{L_e}$$

$$\text{Ratio} = \frac{(4.154 \text{ ft})}{(4.5 \text{ ft})}$$

$$\text{Ratio} = 0.92311$$

Status: **PASS**
Ratio: **0.920**

End-bearing Capacity (ASD)

A - Pile cross-section area

$$A = b D$$

$$A = (48 \text{ in}) \times (48 \text{ in})$$

$$A = 16 \text{ ft}^2$$

q - End-bearing pressure

$$q = \frac{P_c}{A}$$

$$q = \frac{(4.231 \text{ kip})}{(16 \text{ ft}^2)}$$

$$q = 0.26444 \text{ kip/ft}^2$$

$$q = 0.20444 \text{ kip/ft}$$

Check bearing capacity ratio:

Ratio - Capacity

$$\text{Ratio} = \frac{q}{q_a}$$

$$\text{Ratio} = \frac{(0.26444 \text{ kip/ft}^2)}{(2000 \text{ psf})}$$

$$\text{Ratio} = 0.13222$$

Status: **PASS**
Ratio: **0.130**

Czerniak

Lateral Soil Pressure (ASD):

L/D - Length to least lateral dimension ratio,

$$L/D = \frac{L}{D}$$

$$L/D = \frac{(4.5 \text{ ft})}{(48 \text{ in})}$$

$$L/D = 1.125$$

Since $L/D \leq 10$,

Pile is short.

Considering x-direction:

$H_o = -0.1707 \text{ kip/ft}$ - Lateral force per length of pile,

$M_o = 1.4279 \text{ kipft/ft}$ - Overturning moment per length of pile,

a - Distance from resting surface to pivot point,

$$a = \frac{(4 M_o L_e) + (3 H_o L_e^2)}{(6 M_o) + (4 H_o L_e)}$$

$$a = \frac{(4 \times (1.4279 \text{ kipft/ft}) \times (4.5 \text{ ft})) + (3 \times (-0.1707 \text{ kip/ft}) \times (4.5 \text{ ft})^2)}{(6 \times (1.4279 \text{ kipft/ft})) + (4 \times (-0.1707 \text{ kip/ft}) \times (4.5 \text{ ft}))}$$

$$a = 3.099 \text{ ft}$$

p - Earth pressure against the pile at distance $a/2$ from resting surface,

$$p = \frac{0.75 [(4 M_o) + (3 H_o L_e)]^2}{L_e^2 [(3 M_o) + (2 H_o L_e)]}$$

$$p = \frac{0.75 [(4 \times (1.4279 \text{ kipft/ft})) + (3 \times (-0.1707 \text{ kip/ft}) \times (4.5 \text{ ft}))]^2}{(4.5 \text{ ft})^2 [(3 \times (1.4279 \text{ kipft/ft})) + (2 \times (-0.1707 \text{ kip/ft}) \times (4.5 \text{ ft}))]}$$

$$p = 0.15649 \text{ kip/ft}^2$$

s - Earth pressure against the pile at distance L_e ,

$$s = \frac{6 [(2 M_o) + (H_o L_e)]}{L_e^2}$$

$$s = \frac{6 [(2 \times (1.4279 \text{ kipft/ft})) + ((-0.1707 \text{ kip/ft}) \times (4.5 \text{ ft}))]}{(4.5 \text{ ft})^2}$$

$$s = 0.61854 \text{ kip/ft}^2$$

Check lateral soil pressure capacity:

p_a - Allowable lateral soil pressure at depth $a/2$,

$$p_a = R \frac{a}{2}$$

$$p_a = (150 \text{ psf/ft}) \times \frac{(3.099 \text{ ft})}{2}$$

$$p_a = 0.23242 \text{ kip/ft}^2$$

Ratio - Lateral soil capacity

$$\text{Ratio} = \frac{p}{p_a}$$

$$\text{Ratio} = \frac{(0.15649 \text{ kip/ft}^2)}{(0.23242 \text{ kip/ft}^2)}$$

$$\text{Ratio} = 0.67328$$

p_a - Allowable lateral soil pressure at depth L_e ,

Status: **PASS**
Ratio: **0.670**

$$p_s = R L_e$$

$$p_s = (150 \text{ psf/ft}) \times (4.5 \text{ ft})$$

$$p_s = 0.675 \text{ kip/ft}^2$$

Ratio - Lateral soil capacity

$$\text{Ratio} = \frac{s}{p_s}$$

$$\text{Ratio} = \frac{(0.61854 \text{ kip/ft}^2)}{(0.675 \text{ kip/ft}^2)}$$

$$\text{Ratio} = 0.91636$$

Status: **PASS**
Ratio: **0.920**

Considering z-direction:

$H_o = 0.030414 \text{ kip/ft}$ - Lateral force per length of pile,

$M_o = 0.072134 \text{ kipft/ft}$ - Overturning moment per length of pile,

a - Distance from resting surface to pivot point,

$$a = \frac{(4 M_o L_e) + (3 H_o L_e^2)}{(6 M_o) + (4 H_o L_e)}$$

$$a = \frac{(4 \times (0.072134 \text{ kipft/ft}) \times (4.5 \text{ ft})) + (3 \times (0.030414 \text{ kip/ft}) \times (4.5 \text{ ft})^2)}{(6 \times (0.072134 \text{ kipft/ft})) + (4 \times (0.030414 \text{ kip/ft}) \times (4.5 \text{ ft}))}$$

$$a = 3.2094 \text{ ft}$$

p - Earth pressure against the pile at distance $a/2$ from resting surface,

$$p = \frac{0.75 [(4 M_o) + (3 H_o L_e)]^2}{L_e^2 [(3 M_o) + (2 H_o L_e)]}$$

$$p = \frac{0.75 [(4 \times (0.072134 \text{ kipft/ft})) + (3 \times (0.030414 \text{ kip/ft}) \times (4.5 \text{ ft}))]^2}{(4.5 \text{ ft})^2 [(3 \times (0.072134 \text{ kipft/ft})) + (2 \times (0.030414 \text{ kip/ft}) \times (4.5 \text{ ft}))]}$$

$$p = 0.036935 \text{ kip/ft}^2$$

s - Earth pressure against the pile at distance L_e ,

$$s = \frac{6 [(2 M_o) + (H_o L_e)]}{L_e^2}$$

$$s = \frac{6 [(2 \times (0.072134 \text{ kipft/ft})) + ((0.030414 \text{ kip/ft}) \times (4.5 \text{ ft}))]}{(4.5 \text{ ft})^2}$$

$$s = 0.083298 \text{ kip/ft}^2$$

Check lateral soil pressure capacity:

p_a - Allowable lateral soil pressure at depth $a/2$,

$$p_a = R \frac{a}{2}$$

$$p_a = (150 \text{ psf/ft}) \times \frac{(3.2094 \text{ ft})}{2}$$

$$p_a = 0.24071 \text{ kip/ft}^2$$

Ratio - Lateral soil capacity

$$\text{Ratio} = \frac{p}{p_a}$$

$$\text{Ratio} = \frac{(0.036935 \text{ kip/ft}^2)}{(0.24071 \text{ kip/ft}^2)}$$

$$\text{Ratio} = 0.15344$$

p_s - Allowable lateral soil pressure at depth L_e ,

$$p_s = R L_e$$

$$p_s = (150 \text{ psf/ft}) \times (4.5 \text{ ft})$$

$$p_s = 0.675 \text{ kip/ft}^2$$

Ratio - Lateral soil capacity

$$\text{Ratio} = \frac{s}{p_s}$$

Status: **PASS**
Ratio: **0.150**

$$Ratio = \frac{(0.083298 \text{ kip/ft}^2)}{(0.675 \text{ kip/ft}^2)}$$

$$Ratio = 0.1234$$

Status: **PASS**
Ratio: **0.120**

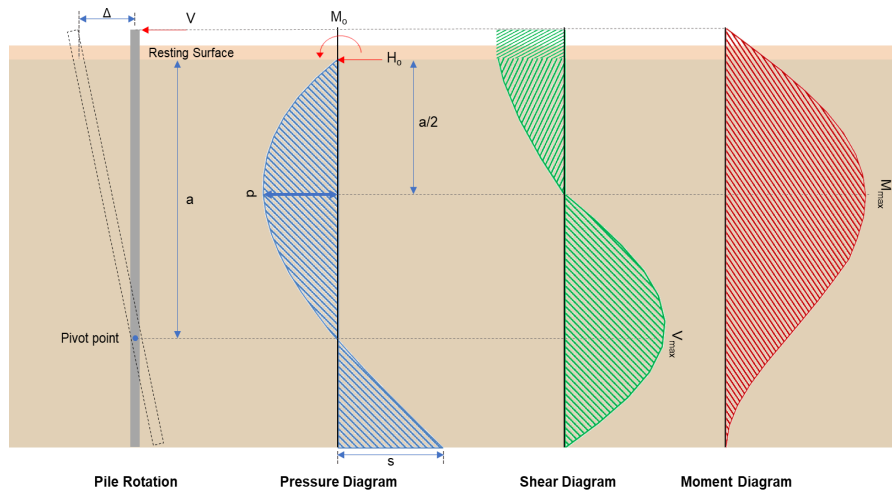

Shear force and Bending moment (x-direction, LRFD)

H_o - Lateral force per length of pile,

$$H_o = \frac{V_x}{1.57 D}$$

$$H_o = \frac{(-1.787 \text{ kip})}{1.57 \times (48 \text{ in})}$$

$$H_o = -0.28455 \text{ kip/ft}$$

M_o - Moment per length of pile,

$$M_o = \frac{M_x + (V_x H)}{1.57 D}$$

$$M_o = \frac{(15.16 \text{ kipft}) + ((-1.787 \text{ kip}) \times (0 \text{ ft}))}{1.57 \times (48 \text{ in})}$$

$$M_o = 2.414 \text{ kipft/ft}$$

E - Distance from lateral load to resisting surface,

$$E = \frac{M_o}{H_o}$$

$$E = \frac{(2.414 \text{ kipft/ft})}{(-0.28455 \text{ kip/ft})}$$

$$E = 8.4835 \text{ ft}$$

a - Distance from resting surface to pivot point,

$$a = \frac{(4 M_o L_c) + (3 H_o L_c^2)}{(6 M_o) + (4 H_o L_c)}$$

$$a = \frac{(4 \times (2.414 \text{ kipft/ft}) \times (4.5 \text{ ft})) + (3 \times (-0.28455 \text{ kip/ft}) \times (4.5 \text{ ft})^2)}{(6 \times (2.414 \text{ kipft/ft})) + (4 \times (-0.28455 \text{ kip/ft}) \times (4.5 \text{ ft}))}$$

$$a = 3.098 \text{ ft}$$

V_{max} - Max shear force located at depth a ,

$$V_{max} = (H_o D) \left[1 - \left[3 \left(\frac{4 E}{L_c} + 3 \right) \left(\frac{a}{L_c} \right)^2 \right] + \left[4 \left(\frac{3 E}{L_c} + 2 \right) \left(\frac{a}{L_c} \right)^3 \right] \right]$$

$$V_{max} = ((-0.28455 \text{ kip/ft}) \times (48 \text{ in})) \times \left[1 - \left[3 \times \left(\frac{4 \times (8.4835 \text{ ft})}{(4.5 \text{ ft})} + 3 \right) \times \left(\frac{(3.098 \text{ ft})}{(4.5 \text{ ft})} \right)^2 \right] + \left[4 \times \left(\frac{3 \times (8.4835 \text{ ft})}{(4.5 \text{ ft})} + 2 \right) \times \left(\frac{(3.098 \text{ ft})}{(4.5 \text{ ft})} \right)^3 \right] \right]$$

$$V_{max} = 4.5481 \text{ kip}$$

M_{max} - Max bending moment located at depth $a/2$,

$$M_{max} = (H_o D L_e) \left[\left(\frac{E}{L_e} + \frac{a}{2 L_e} \right) - \left[\left(\frac{4E}{L_e} + 3 \right) \left(\frac{a}{2 L_e} \right)^3 + \left[\left(\frac{3E}{L_e} + 2 \right) \left(\frac{a}{2 L_e} \right)^4 \right] \right] \right]$$

$$M_{max} = ((-0.28455 \text{ kip/ft}) \times (48 \text{ in}) \times (4.5 \text{ ft})) \times \left[\left(\frac{(8.4835 \text{ ft})}{(4.5 \text{ ft})} + \frac{(3.098 \text{ ft})}{2 \times (4.5 \text{ ft})} \right) - \left[\left(\frac{4 \times (8.4835 \text{ ft})}{(4.5 \text{ ft})} + 3 \right) \times \left(\frac{(3.098 \text{ ft})}{2 \times (4.5 \text{ ft})} \right)^3 + \left[\left(\frac{3 \times (8.4835 \text{ ft})}{(4.5 \text{ ft})} + 2 \right) \times \left(\frac{(3.098 \text{ ft})}{2 \times (4.5 \text{ ft})} \right)^4 \right] \right] \right]$$

$$M_{max} = 9.7676 \text{ kipft}$$

Shear force and Bending moment (z-direction, LRFD)

H_o - Lateral force per length of pile,

$$H_o = \frac{V_z}{1.57 b}$$

$$H_o = \frac{(0.316 \text{ kip})}{1.57 \times (48 \text{ in})}$$

$$H_o = 0.050318 \text{ kip/ft}$$

M_o - Moment per length of pile,

$$M_o = \frac{M_x + (V_z H)}{1.57 b}$$

$$M_o = \frac{(0.758 \text{ kipft}) + ((0.316 \text{ kip}) \times (0 \text{ ft}))}{1.57 \times (48 \text{ in})}$$

$$M_o = 0.1207 \text{ kipft/ft}$$

E - Distance from lateral load to resisting surface,

$$E = \frac{M_o}{H_o}$$

$$E = \frac{(0.1207 \text{ kipft/ft})}{(0.050318 \text{ kip/ft})}$$

$$E = 2.3987 \text{ ft}$$

a - Distance from resting surface to pivot point,

$$a = \frac{(4 M_o L_e) + (3 H_o L_e^2)}{(6 M_o) + (4 H_o L_e)}$$

$$a = \frac{(4 \times (0.1207 \text{ kipft/ft}) \times (4.5 \text{ ft})) + (3 \times (0.050318 \text{ kip/ft}) \times (4.5 \text{ ft})^2)}{(6 \times (0.1207 \text{ kipft/ft})) + (4 \times (0.050318 \text{ kip/ft}) \times (4.5 \text{ ft}))}$$

$$a = 3.2084 \text{ ft}$$

V_{max} - Max shear force located at depth a ,

$$V_{max} = (H_o b) \left[1 - \left[3 \left(\frac{4E}{L_e} + 3 \right) \left(\frac{a}{L_e} \right)^2 + 4 \left(\frac{3E}{L_e} + 2 \right) \left(\frac{a}{L_e} \right)^3 \right] \right]$$

$$V_{max} = ((0.050318 \text{ kip/ft}) \times (48 \text{ in})) \times \left[1 - \left[3 \times \left(\frac{4 \times (2.3987 \text{ ft})}{(4.5 \text{ ft})} + 3 \right) \times \left(\frac{(3.2084 \text{ ft})}{(4.5 \text{ ft})} \right)^2 + 4 \times \left(\frac{3 \times (2.3987 \text{ ft})}{(4.5 \text{ ft})} + 2 \right) \times \left(\frac{(3.2084 \text{ ft})}{(4.5 \text{ ft})} \right)^3 \right] \right]$$

$$V_{max} = 0.32382 \text{ kip}$$

M_{max} - Max bending moment located at depth $a/2$,

$$M_{max} = (H_o b L_e) \left[\left(\frac{E}{L_e} + \frac{a}{2 L_e} \right) - \left[\left(\frac{4E}{L_e} + 3 \right) \left(\frac{a}{2 L_e} \right)^3 + \left[\left(\frac{3E}{L_e} + 2 \right) \left(\frac{a}{2 L_e} \right)^4 \right] \right] \right]$$

$$M_{max} = ((0.050318 \text{ kip/ft}) \times (48 \text{ in}) \times (4.5 \text{ ft})) \times \left[\left(\frac{(2.3987 \text{ ft})}{(4.5 \text{ ft})} + \frac{(3.2084 \text{ ft})}{2 \times (4.5 \text{ ft})} \right) - \left[\left(\frac{4 \times (2.3987 \text{ ft})}{(4.5 \text{ ft})} + 3 \right) \times \left(\frac{(3.2084 \text{ ft})}{2 \times (4.5 \text{ ft})} \right)^3 + \left[\left(\frac{3 \times (2.3987 \text{ ft})}{(4.5 \text{ ft})} + 2 \right) \times \left(\frac{(3.2084 \text{ ft})}{2 \times (4.5 \text{ ft})} \right)^4 \right] \right] \right]$$

$$M_{max} = 0.64774 \text{ kipft}$$

Minimum Reinforcement Check (LRFD)

Parameters:

$f'_{ck} = 2.5 \text{ ksi}$ - Concrete strength,
 $f_{yk} = 60 \text{ ksi}$ - Longitudinal reinforcement strength,
 $\phi = 0.65$ - Reduction factor for axial strength,
 $\alpha = 0.8$ - Alpha factor for axial strength,
 $A_g = 2304 \text{ in}^2$ - Gross area of concrete,

Table 22.4.2.1

Longitudinal reinforcement:

Required reinforcement due to axial load, $A_{st,required}$

22.4.2.2, 10.6.1.1

$A_{st,required}$

$$A_{st,required} = \text{Min} \left[\frac{\frac{P}{\phi \alpha} - (0.85 f'_{ck} A_g)}{f_{yk} - (0.85 f'_{ck})}, (0.08 A_g) \right]$$

$$A_{st,required} = \text{Min} \left[\frac{\frac{(6.977 \text{ kip})}{(0.65) \times (0.8)} - (0.85 \times (2.5 \text{ ksi}) \times (2304 \text{ in}^2))}{(60 \text{ ksi}) - (0.85 \times (2.5 \text{ ksi}))}, (0.08 \times (2304 \text{ in}^2)) \right]$$

$$A_{st,required} = -84.364 \text{ in}^2$$

A_{min} - Governing minimum reinforcement area,

$$A_{min} = \text{Max} [A_{st,required}, (0.0018 A_g)]$$

$$A_{min} = \text{Max} [(-84.364 \text{ in}^2), (0.0018 \times (2304 \text{ in}^2))]$$

$$A_{min} = 4.1472 \text{ in}^2$$

n_{rebar} - Required number of reinforcement,

$$n_{rebar} = \frac{A_{min}}{A_{rebar}}$$

$$n_{rebar} = \frac{(4.1472 \text{ in}^2)}{(0.3068 \text{ in}^2)}$$

$$n_{rebar} = 14$$

A_{st} - Actual total reinforcement area,

$$A_{st} = n_{rebar} \frac{\pi d_{bar}^2}{4}$$

$$A_{st} = (14) \times \frac{\pi \times (0.625 \text{ in})^2}{4}$$

$$A_{st} = 4.2951 \text{ in}^2$$

Ratio - Capacity

$$\text{Ratio} = \frac{A_{min}}{A_{st}}$$

$$\text{Ratio} = \frac{(4.1472 \text{ in}^2)}{(4.2951 \text{ in}^2)}$$

$$\text{Ratio} = 0.96556$$

Status: **PASS**
Ratio: **0.970**

25.2.3

s_{rebar} - Minimum spacing of reinforcement,

$$s_{rebar} = \text{Max} [1.5, (1.5 d_{bar})]$$

$$s_{rebar} = \text{Max} [1.5, (1.5 \times (0.625 \text{ in}))]$$

$$s_{rebar} = 1.5 \text{ in}$$

Ties:

25.7.2.2

Since longitudinal reinforcement is \leq No. 10: Use #3(0.375 in)

25.7.2.1

s_{ties} - Maximum spacing of ties,

$$s_{ties} = \text{Min} [(16 d_{bar}), (48 d_{ties}), \text{Min} (D, b)]$$

$$s_{ties} = \text{Min} [(16 \times (0.625 \text{ in})), (48 \times (0.375 \text{ in})), \text{Min} ((48 \text{ in}), (48 \text{ in}))]$$

$$s_{ties} = 10 \text{ in}$$

Summary:

Main reinforcement: **14 - #5 (0.625 in)**

Ties: #3(0.375 in) - 10 in

Axial Compression Strength (ACI 318-19, LRFD)

22.4.2.2

ϕP_N - Allowable axial compressive strength

$$\phi P_N = \phi 0.80 [(0.85 f'_{ck} [A_g - A_{st}]) + (f_{yk} A_{st})]$$

$$\phi P_N = (0.65) \times 0.80 \times [(0.85 \times (2.5 \text{ ksi}) \times [(2304 \text{ in}^2) - (4.2951 \text{ in}^2)]) + ((60 \text{ ksi}) \times (4.2951 \text{ in}^2))]$$

$$\phi P_N = 2675.2 \text{ kip}$$

Ratio - Capacity

$$\text{Ratio} = \frac{P}{\phi P_N}$$

$$\text{Ratio} = \frac{(6.977 \text{ kip})}{(2675.2 \text{ kip})}$$

$$\text{Ratio} = 0.002608$$

Status: **PASS**
Ratio: **0.000**

Shear Strength (ACI 318-19, LRFD)

Parameters:

22.5.2.2

$b_w = 48 \text{ in}$ - Effective width,
 d - Effective depth

$$d = 0.80 D$$

$$d = 0.80 \times (48 \text{ in})$$

$$d = 38.4 \text{ in}$$

22.5.5.1.3

λ_s - size effect modification factor

$$\lambda_s = \text{MIN} \left[\sqrt{\frac{2}{1 + \frac{d}{10}}}, 1 \right]$$

$$\lambda_s = \text{MIN} \left[\sqrt{\frac{2}{1 + \frac{(38.4 \text{ in})}{10}}}, 1 \right]$$

$$\lambda_s = 0.64282$$

22.5.5.1.1

The following variables were converted to be consistent with empirical formula $f'_{ck} = 2.5 \text{ ksi} \rightarrow 2500 \text{ psi}$,
 $V_{c,max}$ - Max shear strength of concrete

$$V_{c,max} = 5 \lambda_s \sqrt{f'_{ck}} b_w d$$

$$V_{c,max} = 5 \times (0.64282) \times \sqrt{(2500 \text{ psi})} \times (48 \text{ in}) \times (38.4 \text{ in})$$

$$V_{c,max} = 296.21 \text{ kip}$$

22.5.5.1.1(a)

The following variables were converted to be consistent with empirical formula $f'_{ck} = 2.5 \text{ ksi} \rightarrow 2500 \text{ psi}$, $P = 6.977 \text{ kip} \rightarrow 6977 \text{ lbf}$,
 $V_{c,a}$ - Shear strength of concrete (a)

$$V_{c,a} = \left[2 \lambda_s \sqrt{f'_{ck}} + \frac{P}{6 A_g} \right] b_w d$$

$$V_{c,a} = \left[2 \times (0.64282) \times \sqrt{(2500 \text{ psi})} + \frac{(6977 \text{ lbf})}{6 \times (2304 \text{ in}^2)} \right] \times (48 \text{ in}) \times (38.4 \text{ in})$$

$$V_{c,a} = 119.42 \text{ kip}$$

22.5.5.1.2

The following variables were converted to be consistent with empirical formula $f'_{ck} = 2.5 \text{ ksi} \rightarrow 2500 \text{ psi}$,
 $V_{c,b}$ - Shear strength of concrete (b)

$$V_{c,b} = \left[2 \lambda_s \sqrt{f'_{ck}} + (0.05 f'_{ck}) \right] b_w d$$

$$V_{c,b} = \left[2 \times (0.64282) \times \sqrt{(2500 \text{ psi})} + (0.05 \times (2500 \text{ psi})) \right] \times (48 \text{ in}) \times (38.4 \text{ in})$$

$$V_{c,b} = 348.89 \text{ kip}$$

V_c - Governing shear strength of concrete

$$V_c = \text{Min}[V_{c,max}, V_{c,a}, V_{c,b}]$$

$$V_c = \text{Min}[(296.21 \text{ kip}), (119.42 \text{ kip}), (348.89 \text{ kip})]$$

$$V_c = 119.42 \text{ kip}$$

<p>22.5.1.2</p>	<p>The following variables were converted to be consistent with empirical formula $f'_{ck} = 2.5 \text{ ksi} \rightarrow 2500 \text{ psi}$.</p> <p>$V_{s,a}$ - Shear strength of steel (a)</p> $V_{s,a} = 8 \sqrt{f'_{ck}} b_w d$ $V_{s,a} = 8 \times \sqrt{(2500 \text{ psi})} \times (48 \text{ in}) \times (38.4 \text{ in})$ $V_{s,a} = 737.28 \text{ kip}$ <p>A_v - Ties rebar area,</p> $A_v = \frac{\pi d_{ties}^2}{4}$ $A_v = \frac{\pi \times (0.375 \text{ in})^2}{4}$ $A_v = 0.11045 \text{ in}^2$ <p>22.5.8.5.3 $V_{s,b}$ - Shear strength of steel (b)</p> $V_{s,b} = \frac{2 A_v f_{yt} d}{s_{ties}}$ $V_{s,b} = \frac{2 \times (0.11045 \text{ in}^2) \times (60 \text{ ksi}) \times (38.4 \text{ in})}{(10 \text{ in})}$ $V_{s,b} = 50.894 \text{ kip}$ <p>V_s - Governing shear strength of steel</p> $V_s = \text{MIN}[V_{s,a}, V_{s,b}]$ $V_s = \text{MIN}[(737.28 \text{ kip}), (50.894 \text{ kip})]$ $V_s = 50.894 \text{ kip}$ <p>22.5.1.1 ϕV_n - Allowable shear strength</p> $\phi V_n = \phi (V_c + V_s)$ $\phi V_n = (0.65) \times ((119.42 \text{ kip}) + (50.894 \text{ kip}))$ $\phi V_n = 110.7 \text{ kip}$ <p>Considering x-direction:</p> <p>$V_{max} = 4.5481 \text{ kip}$ - Maximum shear force in the x-direction, Ratio - Capacity</p> $\text{Ratio} = \frac{V_{max}}{\phi V_n}$ $\text{Ratio} = \frac{(4.5481 \text{ kip})}{(110.7 \text{ kip})}$ $\text{Ratio} = 0.041084$ <p>Considering z-direction:</p> <p>$V_{max} = 0.32382 \text{ kip}$ - Maximum shear force in the z-direction, Ratio - Capacity</p> $\text{Ratio} = \frac{V_{max}}{\phi V_n}$ $\text{Ratio} = \frac{(0.32382 \text{ kip})}{(110.7 \text{ kip})}$ $\text{Ratio} = 0.0029252$	<p>Status: PASS Ratio: 0.040</p> <p>Status: PASS Ratio: 0.000</p>
	<p>Flexural Strength (ACI 318-19, LRFD)</p> <p>S_m - Section modulus</p> $S_m = \frac{b D^2}{6}$ $S_m = \frac{(48 \text{ in}) \times (48 \text{ in})^2}{6}$ $S_m = 18432 \text{ in}^3$	

<p>14.5.2.1b</p>	<p>$\lambda = 1$ - Concrete modification factor (Normal concrete), Allowable flexural strength: M_n shall be the lesser of: $\phi M_{n,1}$</p> $\phi M_{n,1} = \phi \times 5 \times \lambda \times \sqrt{f'_c} \times S_m$ $\phi M_{n,1} = 0.65 \times 5 \times 1 \times \sqrt{2.5 \text{ ksi}} \times 18432.001 \text{ in}^3$ $\phi M_{n,1} = 249.600 \text{ kipft}$ <p>$\phi M_{n,2}$</p> $\phi M_{n,2} = \phi \times 0.85 \times f'_c \times S_m$ $\phi M_{n,2} = (0.65) \times 0.85 \times (2.5 \text{ ksi}) \times (18432 \text{ in}^3)$ $\phi M_{n,2} = 2121.6 \text{ kipft}$ <p>Therefore, ϕM_n - Allowable flexural strength,</p> $\phi M_n = \text{MIN}[\phi M_{n,1}, \phi M_{n,2}]$ $\phi M_n = \text{MIN}[(249.6 \text{ kipft}), (2121.6 \text{ kipft})]$ $\phi M_n = 249.6 \text{ kipft}$ <p>Considering x-direction: $M_{max} = 9.7676 \text{ kipft}$ - Maximum moment in the x-direction, Ratio - Capacity</p> $\text{Ratio} = \frac{M_{max}}{\phi M_n}$ $\text{Ratio} = \frac{(9.7676 \text{ kipft})}{(249.6 \text{ kipft})}$ $\text{Ratio} = 0.039133$	<p>Status: PASS Ratio: 0.040</p>
	<p>Considering z-direction: $M_{max} = 0.64774 \text{ kipft}$ - Maximum moment in the z-direction, Ratio - Capacity</p> $\text{Ratio} = \frac{M_{max}}{\phi M_n}$ $\text{Ratio} = \frac{(0.64774 \text{ kipft})}{(249.6 \text{ kipft})}$ $\text{Ratio} = 0.0025951$	<p>Status: PASS Ratio: 0.000</p>

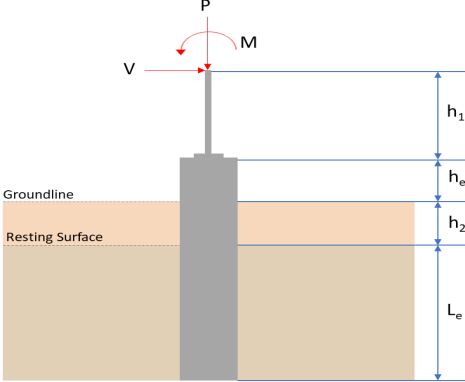
REFERENCES	CALCULATIONS	RESULTS																										
	<p>SkyCiv Foundation Design Pile Foundation</p> <p>Design Information : Design code : IBC 2021 (International Building Code) Unit System : Imperial</p>																											
	<p>Pile Input</p>  <p>Geometry Pile shape: rectangular $b = 48$ in - Pile width $D = 48$ in - Pile depth $L = 4.5$ ft - Total pile length $h_1 = 0$ ft - Lateral load height from the top of the pile, $h_2 = 0$ ft - Depth to resting surface $h_e = 0$ ft - Length of pile above the ground</p> <p>Tabulation of Soil Parameters</p> <table border="1" data-bbox="416 1102 1193 1191"> <thead> <tr> <th>Layer</th> <th>Label</th> <th>Allowable Bearing Pressure (q_a) (psf)</th> <th>Allowable Lateral Pressure (R) (psf/ft)</th> </tr> </thead> <tbody> <tr> <td>1</td> <td>Sand, silty sand, clayey sand, silty gravel & clayey gravel</td> <td>2000.000</td> <td>150.000</td> </tr> </tbody> </table> <p>Tabulation of Loads</p> <table border="1" data-bbox="676 1285 935 1458"> <thead> <tr> <th>Load Component</th> <th>ASD</th> <th>LRFD</th> </tr> </thead> <tbody> <tr> <td>P (kip)</td> <td>4.231</td> <td>6.977</td> </tr> <tr> <td>V_x (kip)</td> <td>-1.072</td> <td>-1.787</td> </tr> <tr> <td>V_z (kip)</td> <td>-0.191</td> <td>-0.316</td> </tr> <tr> <td>M_x (kipft)</td> <td>-0.453</td> <td>-0.758</td> </tr> <tr> <td>M_z (kipft)</td> <td>8.967</td> <td>15.160</td> </tr> </tbody> </table> <p>Material Properties $f'_{ck} = 2.5$ ksi - Concrete strength,</p>	Layer	Label	Allowable Bearing Pressure (q_a) (psf)	Allowable Lateral Pressure (R) (psf/ft)	1	Sand, silty sand, clayey sand, silty gravel & clayey gravel	2000.000	150.000	Load Component	ASD	LRFD	P (kip)	4.231	6.977	V_x (kip)	-1.072	-1.787	V_z (kip)	-0.191	-0.316	M_x (kipft)	-0.453	-0.758	M_z (kipft)	8.967	15.160	
Layer	Label	Allowable Bearing Pressure (q_a) (psf)	Allowable Lateral Pressure (R) (psf/ft)																									
1	Sand, silty sand, clayey sand, silty gravel & clayey gravel	2000.000	150.000																									
Load Component	ASD	LRFD																										
P (kip)	4.231	6.977																										
V_x (kip)	-1.072	-1.787																										
V_z (kip)	-0.191	-0.316																										
M_x (kipft)	-0.453	-0.758																										
M_z (kipft)	8.967	15.160																										
	<p>Required depth to resist lateral loads (ASD) H - Point of application of the lateral load</p> $H = h_1 + h_2 + h_e$ $H = (0 \text{ ft}) + (0 \text{ ft}) + (0 \text{ ft})$ $H = 0 \text{ ft}$ <p>Considering x-direction: H_o - Lateral force per length of pile,</p> $H_o = \frac{V_x}{1.57 D}$ $H_o = \frac{(-1.072 \text{ kip})}{1.57 \times (48 \text{ in})}$ $H_o = -0.1707 \text{ kip/ft}$ <p>M_o - Moment per length of pile,</p> $M_o = \frac{M_z + (V_x H)}{1.57 D}$																											

$$M_o = \frac{(8.967 \text{ kipft}) + ((-1.072 \text{ kip}) \times (0 \text{ ft}))}{1.57 \times (48 \text{ in})}$$

$$M_o = 1.4279 \text{ kipft/ft}$$

Required depth of embedment in earth:

$$L_x^3 - \left(14.14 \times \frac{H_o \times L_x}{R}\right) - \left(18.85 \times \frac{M_o}{R}\right) = 0$$

Solving the cubic equation:

$L_{e,x} = 4.1541 \text{ ft}$ - Required depth in x-direction,

Considering z-direction:

H_o - Lateral force per length of pile,

$$H_o = \frac{V_z}{1.57 b}$$

$$H_o = \frac{(-0.191 \text{ kip})}{1.57 \times (48 \text{ in})}$$

$$H_o = -0.030414 \text{ kip/ft}$$

M_o - Moment per length of pile,

$$M_o = \frac{M_x + (V_z H)}{1.57 b}$$

$$M_o = \frac{(0.453 \text{ kipft}) + ((-0.191 \text{ kip}) \times (0 \text{ ft}))}{1.57 \times (48 \text{ in})}$$

$$M_o = 0.072134 \text{ kipft/ft}$$

Required depth of embedment in earth:

$$L_z^3 - \left(14.14 \times \frac{H_o \times L_z}{R}\right) - \left(18.85 \times \frac{M_o}{R}\right) = 0$$

Solving the cubic equation:

$L_{e,z} = 1.4593 \text{ ft}$ - Required depth in z-direction,

Minimum embedded depth required:

$L_{e,req}$ - Depth of pile required,

$$L_{e,req} = \text{MAX}[L_{e,x}, L_{e,z}]$$

$$L_{e,req} = \text{MAX}[(4.1541 \text{ ft}), (1.4593 \text{ ft})]$$

$$L_{e,req} = 4.154 \text{ ft}$$

L_e - Actual embedded length of pile,

$$L_e = L - h_c - h_2$$

$$L_e = (4.5 \text{ ft}) - (0 \text{ ft}) - (0 \text{ ft})$$

$$L_e = 4.5 \text{ ft}$$

Ratio - Embedded depth

$$\text{Ratio} = \frac{L_{e,req}}{L_e}$$

$$\text{Ratio} = \frac{(4.154 \text{ ft})}{(4.5 \text{ ft})}$$

$$\text{Ratio} = 0.92311$$

Status: **PASS**
Ratio: **0.920**

End-bearing Capacity (ASD)

A - Pile cross-section area

$$A = b D$$

$$A = (48 \text{ in}) \times (48 \text{ in})$$

$$A = 16 \text{ ft}^2$$

q - End-bearing pressure

$$q = \frac{P_c}{A}$$

$$q = \frac{(4.231 \text{ kip})}{(16 \text{ ft}^2)}$$

$$q = 0.26444 \text{ kip/ft}^2$$

$$q = 0.26444 \text{ kip/ft}^2$$

Check bearing capacity ratio:

Ratio - Capacity

$$\text{Ratio} = \frac{q}{q_a}$$

$$\text{Ratio} = \frac{(0.26444 \text{ kip/ft}^2)}{(2000 \text{ psf})}$$

$$\text{Ratio} = 0.13222$$

Status: **PASS**
Ratio: **0.130**

Czerniak

Lateral Soil Pressure (ASD):

L/D - Length to least lateral dimension ratio,

$$L/D = \frac{L}{D}$$

$$L/D = \frac{(4.5 \text{ ft})}{(48 \text{ in})}$$

$$L/D = 1.125$$

Since $L/D \leq 10$,

Pile is short.

Considering x-direction:

$H_o = -0.1707 \text{ kip/ft}$ - Lateral force per length of pile,

$M_o = 1.4279 \text{ kipft/ft}$ - Overturning moment per length of pile,

a - Distance from resting surface to pivot point,

$$a = \frac{(4 M_o L_e) + (3 H_o L_e^2)}{(6 M_o) + (4 H_o L_e)}$$

$$a = \frac{(4 \times (1.4279 \text{ kipft/ft}) \times (4.5 \text{ ft})) + (3 \times (-0.1707 \text{ kip/ft}) \times (4.5 \text{ ft})^2)}{(6 \times (1.4279 \text{ kipft/ft})) + (4 \times (-0.1707 \text{ kip/ft}) \times (4.5 \text{ ft}))}$$

$$a = 3.099 \text{ ft}$$

p - Earth pressure against the pile at distance $a/2$ from resting surface,

$$p = \frac{0.75 [(4 M_o) + (3 H_o L_e)]^2}{L_e^2 [(3 M_o) + (2 H_o L_e)]}$$

$$p = \frac{0.75 [(4 \times (1.4279 \text{ kipft/ft})) + (3 \times (-0.1707 \text{ kip/ft}) \times (4.5 \text{ ft}))]^2}{(4.5 \text{ ft})^2 [(3 \times (1.4279 \text{ kipft/ft})) + (2 \times (-0.1707 \text{ kip/ft}) \times (4.5 \text{ ft}))]}$$

$$p = 0.15649 \text{ kip/ft}^2$$

s - Earth pressure against the pile at distance L_e ,

$$s = \frac{6 [(2 M_o) + (H_o L_e)]}{L_e^2}$$

$$s = \frac{6 [(2 \times (1.4279 \text{ kipft/ft})) + ((-0.1707 \text{ kip/ft}) \times (4.5 \text{ ft}))]}{(4.5 \text{ ft})^2}$$

$$s = 0.61854 \text{ kip/ft}^2$$

Check lateral soil pressure capacity:

p_a - Allowable lateral soil pressure at depth $a/2$,

$$p_a = R \frac{a}{2}$$

$$p_a = (150 \text{ psf/ft}) \times \frac{(3.099 \text{ ft})}{2}$$

$$p_a = 0.23242 \text{ kip/ft}^2$$

Ratio - Lateral soil capacity

$$\text{Ratio} = \frac{p}{p_a}$$

$$\text{Ratio} = \frac{(0.15649 \text{ kip/ft}^2)}{(0.23242 \text{ kip/ft}^2)}$$

$$\text{Ratio} = 0.67328$$

p_s - Allowable lateral soil pressure at depth L_e ,

Status: **PASS**
Ratio: **0.670**

$$p_s = R L_e$$

$$p_s = (150 \text{ psf/ft}) \times (4.5 \text{ ft})$$

$$p_s = 0.675 \text{ kip/ft}^2$$

Ratio - Lateral soil capacity

$$\text{Ratio} = \frac{s}{p_s}$$

$$\text{Ratio} = \frac{(0.61854 \text{ kip/ft}^2)}{(0.675 \text{ kip/ft}^2)}$$

$$\text{Ratio} = 0.91636$$

Status: **PASS**
Ratio: **0.920**

Considering z-direction:

$H_o = -0.030414 \text{ kip/ft}$ - Lateral force per length of pile,

$M_o = 0.072134 \text{ kipft/ft}$ - Overturning moment per length of pile,

a - Distance from resting surface to pivot point,

$$a = \frac{(4 M_o L_e) + (3 H_o L_e^2)}{(6 M_o) + (4 H_o L_e)}$$

$$a = \frac{(4 \times (0.072134 \text{ kipft/ft}) \times (4.5 \text{ ft})) + (3 \times (-0.030414 \text{ kip/ft}) \times (4.5 \text{ ft})^2)}{(6 \times (0.072134 \text{ kipft/ft})) + (4 \times (-0.030414 \text{ kip/ft}) \times (4.5 \text{ ft}))}$$

$$a = 3.2094 \text{ ft}$$

p - Earth pressure against the pile at distance $a/2$ from resting surface,

$$p = \frac{0.75 [(4 M_o) + (3 H_o L_e)]^2}{L_e^2 [(3 M_o) + (2 H_o L_e)]}$$

$$p = \frac{0.75 \times [(4 \times (0.072134 \text{ kipft/ft})) + (3 \times (-0.030414 \text{ kip/ft}) \times (4.5 \text{ ft}))]^2}{(4.5 \text{ ft})^2 \times [(3 \times (0.072134 \text{ kipft/ft})) + (2 \times (-0.030414 \text{ kip/ft}) \times (4.5 \text{ ft}))]}$$

$$p = -0.0096249 \text{ kip/ft}^2$$

s - Earth pressure against the pile at distance L_e ,

$$s = \frac{6 [(2 M_o) + (H_o L_e)]}{L_e^2}$$

$$s = \frac{6 \times [(2 \times (0.072134 \text{ kipft/ft})) + ((-0.030414 \text{ kip/ft}) \times (4.5 \text{ ft}))]}{(4.5 \text{ ft})^2}$$

$$s = 0.0021939 \text{ kip/ft}^2$$

Check lateral soil pressure capacity:

p_a - Allowable lateral soil pressure at depth $a/2$,

$$p_a = R \frac{a}{2}$$

$$p_a = (150 \text{ psf/ft}) \times \frac{(3.2094 \text{ ft})}{2}$$

$$p_a = 0.24071 \text{ kip/ft}^2$$

Ratio - Lateral soil capacity

$$\text{Ratio} = \frac{p}{p_a}$$

$$\text{Ratio} = \frac{(-0.0096249 \text{ kip/ft}^2)}{(0.24071 \text{ kip/ft}^2)}$$

$$\text{Ratio} = -0.039986$$

p_s - Allowable lateral soil pressure at depth L_e ,

$$p_s = R L_e$$

$$p_s = (150 \text{ psf/ft}) \times (4.5 \text{ ft})$$

$$p_s = 0.675 \text{ kip/ft}^2$$

Ratio - Lateral soil capacity

$$\text{Ratio} = \frac{s}{p_s}$$

Status: **PASS**
Ratio: **-0.040**

$$Ratio = \frac{(0.0021939 \text{ kip/ft}^2)}{(0.675 \text{ kip/ft}^2)}$$

$$Ratio = 0.0032502$$

Status: **PASS**
Ratio: **0.000**

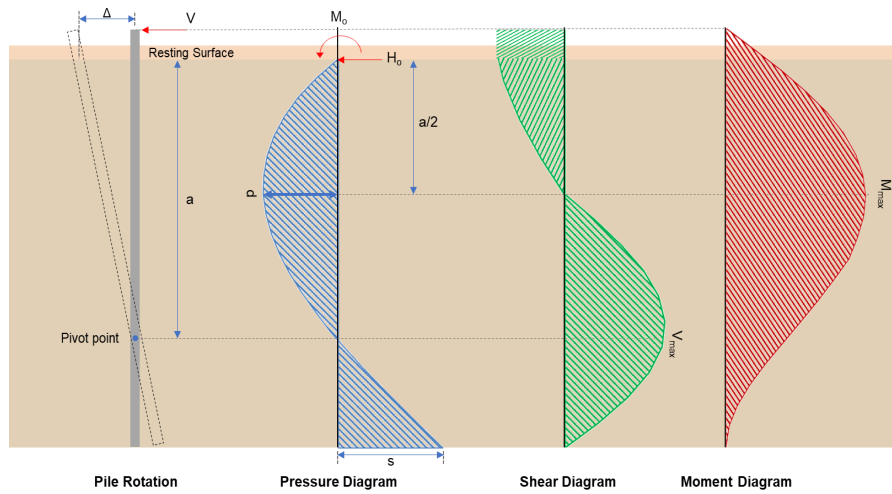

Shear force and Bending moment (x-direction, LRFD)

H_o - Lateral force per length of pile,

$$H_o = \frac{V_x}{1.57 D}$$

$$H_o = \frac{(-1.787 \text{ kip})}{1.57 \times (48 \text{ in})}$$

$$H_o = -0.28455 \text{ kip/ft}$$

M_o - Moment per length of pile,

$$M_o = \frac{M_x + (V_x H)}{1.57 D}$$

$$M_o = \frac{(15.16 \text{ kipft}) + ((-1.787 \text{ kip}) \times (0 \text{ ft}))}{1.57 \times (48 \text{ in})}$$

$$M_o = 2.414 \text{ kipft/ft}$$

E - Distance from lateral load to resisting surface,

$$E = \frac{M_o}{H_o}$$

$$E = \frac{(2.414 \text{ kipft/ft})}{(-0.28455 \text{ kip/ft})}$$

$$E = 8.4835 \text{ ft}$$

a - Distance from resting surface to pivot point,

$$a = \frac{(4 M_o L_c) + (3 H_o L_c^2)}{(6 M_o) + (4 H_o L_c)}$$

$$a = \frac{(4 \times (2.414 \text{ kipft/ft}) \times (4.5 \text{ ft})) + (3 \times (-0.28455 \text{ kip/ft}) \times (4.5 \text{ ft})^2)}{(6 \times (2.414 \text{ kipft/ft})) + (4 \times (-0.28455 \text{ kip/ft}) \times (4.5 \text{ ft}))}$$

$$a = 3.098 \text{ ft}$$

V_{max} - Max shear force located at depth a ,

$$V_{max} = (H_o D) \left[1 - \left[3 \left(\frac{4 E}{L_c} + 3 \right) \left(\frac{a}{L_c} \right)^2 \right] + \left[4 \left(\frac{3 E}{L_c} + 2 \right) \left(\frac{a}{L_c} \right)^3 \right] \right]$$

$$V_{max} = ((-0.28455 \text{ kip/ft}) \times (48 \text{ in})) \times \left[1 - \left[3 \times \left(\frac{4 \times (8.4835 \text{ ft})}{(4.5 \text{ ft})} + 3 \right) \times \left(\frac{(3.098 \text{ ft})}{(4.5 \text{ ft})} \right)^2 \right] + \left[4 \times \left(\frac{3 \times (8.4835 \text{ ft})}{(4.5 \text{ ft})} + 2 \right) \times \left(\frac{(3.098 \text{ ft})}{(4.5 \text{ ft})} \right)^3 \right] \right]$$

$$V_{max} = 4.5481 \text{ kip}$$

M_{max} - Max bending moment located at depth $a/2$,

$$M_{max} = (H_o D L_e) \left[\left(\frac{E}{L_e} + \frac{a}{2 L_e} \right) - \left[\left(\frac{4E}{L_e} + 3 \right) \left(\frac{a}{2 L_e} \right)^3 \right] + \left[\left(\frac{3E}{L_e} + 2 \right) \left(\frac{a}{2 L_e} \right)^4 \right] \right]$$

$$M_{max} = ((-0.28455 \text{ kip/ft}) \times (48 \text{ in}) \times (4.5 \text{ ft})) \times \left[\left(\frac{(8.4835 \text{ ft})}{(4.5 \text{ ft})} + \frac{(3.098 \text{ ft})}{2 \times (4.5 \text{ ft})} \right) - \left[\left(\frac{4 \times (8.4835 \text{ ft})}{(4.5 \text{ ft})} + 3 \right) \times \left(\frac{(3.098 \text{ ft})}{2 \times (4.5 \text{ ft})} \right)^3 \right] + \left[\left(\frac{3 \times (8.4835 \text{ ft})}{(4.5 \text{ ft})} + 2 \right) \times \left(\frac{(3.098 \text{ ft})}{2 \times (4.5 \text{ ft})} \right)^4 \right] \right]$$

$$M_{max} = 9.7676 \text{ kipft}$$

Shear force and Bending moment (z-direction, LRFD)

H_o - Lateral force per length of pile,

$$H_o = \frac{V_z}{1.57 b}$$

$$H_o = \frac{(-0.316 \text{ kip})}{1.57 \times (48 \text{ in})}$$

$$H_o = -0.050318 \text{ kip/ft}$$

M_o - Moment per length of pile,

$$M_o = \frac{M_x + (V_z H)}{1.57 b}$$

$$M_o = \frac{(0.758 \text{ kipft}) + ((-0.316 \text{ kip}) \times (0 \text{ ft}))}{1.57 \times (48 \text{ in})}$$

$$M_o = 0.1207 \text{ kipft/ft}$$

E - Distance from lateral load to resisting surface,

$$E = \frac{M_o}{H_o}$$

$$E = \frac{(0.1207 \text{ kipft/ft})}{(-0.050318 \text{ kip/ft})}$$

$$E = 2.3987 \text{ ft}$$

a - Distance from resting surface to pivot point,

$$a = \frac{(4 M_o L_e) + (3 H_o L_e^2)}{(6 M_o) + (4 H_o L_e)}$$

$$a = \frac{(4 \times (0.1207 \text{ kipft/ft}) \times (4.5 \text{ ft})) + (3 \times (-0.050318 \text{ kip/ft}) \times (4.5 \text{ ft})^2)}{(6 \times (0.1207 \text{ kipft/ft})) + (4 \times (-0.050318 \text{ kip/ft}) \times (4.5 \text{ ft}))}$$

$$a = 3.2084 \text{ ft}$$

V_{max} - Max shear force located at depth a ,

$$V_{max} = (H_o b) \left[1 - \left[3 \left(\frac{4E}{L_e} + 3 \right) \left(\frac{a}{L_e} \right)^2 \right] + \left[4 \left(\frac{3E}{L_e} + 2 \right) \left(\frac{a}{L_e} \right)^3 \right] \right]$$

$$V_{max} = ((-0.050318 \text{ kip/ft}) \times (48 \text{ in})) \times \left[1 - \left[3 \times \left(\frac{4 \times (2.3987 \text{ ft})}{(4.5 \text{ ft})} + 3 \right) \times \left(\frac{(3.2084 \text{ ft})}{(4.5 \text{ ft})} \right)^2 \right] + \left[4 \times \left(\frac{3 \times (2.3987 \text{ ft})}{(4.5 \text{ ft})} + 2 \right) \times \left(\frac{(3.2084 \text{ ft})}{(4.5 \text{ ft})} \right)^3 \right] \right]$$

$$V_{max} = 0.32382 \text{ kip}$$

M_{max} - Max bending moment located at depth $a/2$,

$$M_{max} = (H_o b L_e) \left[\left(\frac{E}{L_e} + \frac{a}{2 L_e} \right) - \left[\left(\frac{4E}{L_e} + 3 \right) \left(\frac{a}{2 L_e} \right)^3 \right] + \left[\left(\frac{3E}{L_e} + 2 \right) \left(\frac{a}{2 L_e} \right)^4 \right] \right]$$

$$M_{max} = ((-0.050318 \text{ kip/ft}) \times (48 \text{ in}) \times (4.5 \text{ ft})) \times \left[\left(\frac{(2.3987 \text{ ft})}{(4.5 \text{ ft})} + \frac{(3.2084 \text{ ft})}{2 \times (4.5 \text{ ft})} \right) - \left[\left(\frac{4 \times (2.3987 \text{ ft})}{(4.5 \text{ ft})} + 3 \right) \times \left(\frac{(3.2084 \text{ ft})}{2 \times (4.5 \text{ ft})} \right)^3 \right] + \left[\left(\frac{3 \times (2.3987 \text{ ft})}{(4.5 \text{ ft})} + 2 \right) \times \left(\frac{(3.2084 \text{ ft})}{2 \times (4.5 \text{ ft})} \right)^4 \right] \right]$$

$$M_{max} = 0.64774 \text{ kipft}$$

Minimum Reinforcement Check (LRFD)

Parameters:

$f'_{ck} = 2.5 \text{ ksi}$ - Concrete strength,
 $f_{yk} = 60 \text{ ksi}$ - Longitudinal reinforcement strength,
 $\phi = 0.65$ - Reduction factor for axial strength,
 $\alpha = 0.8$ - Alpha factor for axial strength,
 $A_g = 2304 \text{ in}^2$ - Gross area of concrete,

Table 22.4.2.1

Longitudinal reinforcement:

Required reinforcement due to axial load, $A_{st,required}$

22.4.2.2, 10.6.1.1

$A_{st,required}$

$$A_{st,required} = \text{Min} \left[\frac{\frac{P}{\phi \alpha} - (0.85 f'_{ck} A_g)}{f_{yk} - (0.85 f'_{ck})}, (0.08 A_g) \right]$$

$$A_{st,required} = \text{Min} \left[\frac{\frac{(6.977 \text{ kip})}{(0.65) \times (0.8)} - (0.85 \times (2.5 \text{ ksi}) \times (2304 \text{ in}^2))}{(60 \text{ ksi}) - (0.85 \times (2.5 \text{ ksi}))}, (0.08 \times (2304 \text{ in}^2)) \right]$$

$$A_{st,required} = -84.364 \text{ in}^2$$

A_{min} - Governing minimum reinforcement area,

$$A_{min} = \text{Max} [A_{st,required}, (0.0018 A_g)]$$

$$A_{min} = \text{Max} [(-84.364 \text{ in}^2), (0.0018 \times (2304 \text{ in}^2))]$$

$$A_{min} = 4.1472 \text{ in}^2$$

n_{rebar} - Required number of reinforcement,

$$n_{rebar} = \frac{A_{min}}{A_{rebar}}$$

$$n_{rebar} = \frac{(4.1472 \text{ in}^2)}{(0.3068 \text{ in}^2)}$$

$$n_{rebar} = 14$$

A_{st} - Actual total reinforcement area,

$$A_{st} = n_{rebar} \frac{\pi d_{bar}^2}{4}$$

$$A_{st} = (14) \times \frac{\pi \times (0.625 \text{ in})^2}{4}$$

$$A_{st} = 4.2951 \text{ in}^2$$

Ratio - Capacity

$$\text{Ratio} = \frac{A_{min}}{A_{st}}$$

$$\text{Ratio} = \frac{(4.1472 \text{ in}^2)}{(4.2951 \text{ in}^2)}$$

$$\text{Ratio} = 0.96556$$

Status: **PASS**
Ratio: **0.970**

25.2.3 s_{rebar} - Minimum spacing of reinforcement,

$$s_{rebar} = \text{Max} [1.5, (1.5 d_{bar})]$$

$$s_{rebar} = \text{Max} [1.5, (1.5 \times (0.625 \text{ in}))]$$

$$s_{rebar} = 1.5 \text{ in}$$

Ties:

25.7.2.2 Since longitudinal reinforcement is \leq No. 10: Use #3(0.375 in)

25.7.2.1 s_{ties} - Maximum spacing of ties,

$$s_{ties} = \text{Min} [(16 d_{bar}), (48 d_{ties}), \text{Min} (D, b)]$$

$$s_{ties} = \text{Min} [(16 \times (0.625 \text{ in})), (48 \times (0.375 \text{ in})), \text{Min} ((48 \text{ in}), (48 \text{ in}))]$$

$$s_{ties} = 10 \text{ in}$$

Summary:

Main reinforcement: **14 - #5 (0.625 in)**

Ties: #3(0.375 in) - 10 in

Axial Compression Strength (ACI 318-19, LRFD)

22.4.2.2

ϕP_N - Allowable axial compressive strength

$$\phi P_N = \phi 0.80 [(0.85 f'_{ck} [A_g - A_{st}]) + (f_{yk} A_{st})]$$

$$\phi P_N = (0.65) \times 0.80 \times [(0.85 \times (2.5 \text{ ksi}) \times [(2304 \text{ in}^2) - (4.2951 \text{ in}^2)]) + ((60 \text{ ksi}) \times (4.2951 \text{ in}^2))]$$

$$\phi P_N = 2675.2 \text{ kip}$$

Ratio - Capacity

$$\text{Ratio} = \frac{P}{\phi P_N}$$

$$\text{Ratio} = \frac{(6.977 \text{ kip})}{(2675.2 \text{ kip})}$$

$$\text{Ratio} = 0.002608$$

Status: **PASS**
Ratio: **0.000**

Shear Strength (ACI 318-19, LRFD)

Parameters:

22.5.2.2

$b_w = 48 \text{ in}$ - Effective width,
 d - Effective depth

$$d = 0.80 D$$

$$d = 0.80 \times (48 \text{ in})$$

$$d = 38.4 \text{ in}$$

22.5.5.1.3

λ_s - size effect modification factor

$$\lambda_s = \text{MIN} \left[\sqrt{\frac{2}{1 + \frac{d}{10}}}, 1 \right]$$

$$\lambda_s = \text{MIN} \left[\sqrt{\frac{2}{1 + \frac{(38.4 \text{ in})}{10}}}, 1 \right]$$

$$\lambda_s = 0.64282$$

22.5.5.1.1

The following variables were converted to be consistent with empirical formula $f'_{ck} = 2.5 \text{ ksi} \rightarrow 2500 \text{ psi}$,
 $V_{c,max}$ - Max shear strength of concrete

$$V_{c,max} = 5 \lambda_s \sqrt{f'_{ck}} b_w d$$

$$V_{c,max} = 5 \times (0.64282) \times \sqrt{(2500 \text{ psi})} \times (48 \text{ in}) \times (38.4 \text{ in})$$

$$V_{c,max} = 296.21 \text{ kip}$$

22.5.5.1.1(a)

The following variables were converted to be consistent with empirical formula $f'_{ck} = 2.5 \text{ ksi} \rightarrow 2500 \text{ psi}$, $P = 6.977 \text{ kip} \rightarrow 6977 \text{ lbf}$,
 $V_{c,a}$ - Shear strength of concrete (a)

$$V_{c,a} = \left[2 \lambda_s \sqrt{f'_{ck}} + \frac{P}{6 A_g} \right] b_w d$$

$$V_{c,a} = \left[2 \times (0.64282) \times \sqrt{(2500 \text{ psi})} + \frac{(6977 \text{ lbf})}{6 \times (2304 \text{ in}^2)} \right] \times (48 \text{ in}) \times (38.4 \text{ in})$$

$$V_{c,a} = 119.42 \text{ kip}$$

22.5.5.1.2

The following variables were converted to be consistent with empirical formula $f'_{ck} = 2.5 \text{ ksi} \rightarrow 2500 \text{ psi}$,
 $V_{c,b}$ - Shear strength of concrete (b)

$$V_{c,b} = \left[2 \lambda_s \sqrt{f'_{ck}} + (0.05 f'_{ck}) \right] b_w d$$

$$V_{c,b} = \left[2 \times (0.64282) \times \sqrt{(2500 \text{ psi})} + (0.05 \times (2500 \text{ psi})) \right] \times (48 \text{ in}) \times (38.4 \text{ in})$$

$$V_{c,b} = 348.89 \text{ kip}$$

V_c - Governing shear strength of concrete

$$V_c = \text{Min}[V_{c,max}, V_{c,a}, V_{c,b}]$$

$$V_c = \text{Min}[(296.21 \text{ kip}), (119.42 \text{ kip}), (348.89 \text{ kip})]$$

$$V_c = 119.42 \text{ kip}$$

<p>22.5.1.2</p>	<p>The following variables were converted to be consistent with empirical formula $f'_{ck} = 2.5 \text{ ksi} \rightarrow 2500 \text{ psi}$.</p> <p>$V_{s,a}$ - Shear strength of steel (a)</p> $V_{s,a} = 8 \sqrt{f'_{ck}} b_w d$ $V_{s,a} = 8 \times \sqrt{(2500 \text{ psi})} \times (48 \text{ in}) \times (38.4 \text{ in})$ $V_{s,a} = 737.28 \text{ kip}$ <p>A_v - Ties rebar area,</p> $A_v = \frac{\pi d_{ties}^2}{4}$ $A_v = \frac{\pi \times (0.375 \text{ in})^2}{4}$ $A_v = 0.11045 \text{ in}^2$ <p>22.5.8.5.3 $V_{s,b}$ - Shear strength of steel (b)</p> $V_{s,b} = \frac{2 A_v f_{yt} d}{s_{ties}}$ $V_{s,b} = \frac{2 \times (0.11045 \text{ in}^2) \times (60 \text{ ksi}) \times (38.4 \text{ in})}{(10 \text{ in})}$ $V_{s,b} = 50.894 \text{ kip}$ <p>V_s - Governing shear strength of steel</p> $V_s = \text{MIN}[V_{s,a}, V_{s,b}]$ $V_s = \text{MIN}[(737.28 \text{ kip}), (50.894 \text{ kip})]$ $V_s = 50.894 \text{ kip}$ <p>22.5.1.1 ϕV_n - Allowable shear strength</p> $\phi V_n = \phi (V_c + V_s)$ $\phi V_n = (0.65) \times ((119.42 \text{ kip}) + (50.894 \text{ kip}))$ $\phi V_n = 110.7 \text{ kip}$ <p>Considering x-direction:</p> <p>$V_{max} = 4.5481 \text{ kip}$ - Maximum shear force in the x-direction, Ratio - Capacity</p> $\text{Ratio} = \frac{V_{max}}{\phi V_n}$ $\text{Ratio} = \frac{(4.5481 \text{ kip})}{(110.7 \text{ kip})}$ $\text{Ratio} = 0.041084$ <p>Considering z-direction:</p> <p>$V_{max} = 0.32382 \text{ kip}$ - Maximum shear force in the z-direction, Ratio - Capacity</p> $\text{Ratio} = \frac{V_{max}}{\phi V_n}$ $\text{Ratio} = \frac{(0.32382 \text{ kip})}{(110.7 \text{ kip})}$ $\text{Ratio} = 0.0029252$	<p>Status: PASS Ratio: 0.040</p> <p>Status: PASS Ratio: 0.000</p>
	<p>Flexural Strength (ACI 318-19, LRFD)</p> <p>S_m - Section modulus</p> $S_m = \frac{b D^2}{6}$ $S_m = \frac{(48 \text{ in}) \times (48 \text{ in})^2}{6}$ $S_m = 18432 \text{ in}^3$	

<p>14.5.2.1b</p>	<p>$\lambda = 1$ - Concrete modification factor (Normal concrete), Allowable flexural strength: M_n shall be the lesser of: $\phi M_{n,1}$</p> $\phi M_{n,1} = \phi \times 5 \times \lambda \times \sqrt{f'_c} \times S_m$ $\phi M_{n,1} = 0.65 \times 5 \times 1 \times \sqrt{2.5 \text{ ksi}} \times 18432.001 \text{ in}^3$ $\phi M_{n,1} = 249.600 \text{ kipft}$ <p>$\phi M_{n,2}$</p> $\phi M_{n,2} = \phi \times 0.85 \times f'_c \times S_m$ $\phi M_{n,2} = (0.65) \times 0.85 \times (2.5 \text{ ksi}) \times (18432 \text{ in}^3)$ $\phi M_{n,2} = 2121.6 \text{ kipft}$ <p>Therefore, ϕM_n - Allowable flexural strength,</p> $\phi M_n = \text{MIN}[\phi M_{n,1}, \phi M_{n,2}]$ $\phi M_n = \text{MIN}[(249.6 \text{ kipft}), (2121.6 \text{ kipft})]$ $\phi M_n = 249.6 \text{ kipft}$ <p>Considering x-direction: $M_{max} = 9.7676 \text{ kipft}$ - Maximum moment in the x-direction, Ratio - Capacity</p> $\text{Ratio} = \frac{M_{max}}{\phi M_n}$ $\text{Ratio} = \frac{(9.7676 \text{ kipft})}{(249.6 \text{ kipft})}$ $\text{Ratio} = 0.039133$	<p>Status: PASS Ratio: 0.040</p>
	<p>Considering z-direction: $M_{max} = 0.64774 \text{ kipft}$ - Maximum moment in the z-direction, Ratio - Capacity</p> $\text{Ratio} = \frac{M_{max}}{\phi M_n}$ $\text{Ratio} = \frac{(0.64774 \text{ kipft})}{(249.6 \text{ kipft})}$ $\text{Ratio} = 0.0025951$	<p>Status: PASS Ratio: 0.000</p>